

## RULE 9B-3.0475

### HURRICANE MITIGATION RETROFITS FOR EXISTING SITE-BUILT SINGLE FAMILY RESIDENTIAL STRUCTURES

**101 Retrofits Required.** Pursuant to Section 553.844, Florida Statutes, strengthening of existing site-built, single family residential structures to resist hurricanes shall be provided. Site built single- family residential structures shall mean site built single family detached residential structures.

- 101.1** When a roof on an existing site-built, single family residential structure is replaced, the following procedures shall be permitted to be performed by the roofing contractor:
- (a) Roof-decking attachment and fasteners shall be strengthened and corrected as required by section 201.1.
  - (b) A secondary water barrier shall be provided as required by section 201.2.
- 101.2** When a roof is replaced on a building that is located in the wind-borne debris region as defined in s. 1609.2 of the Florida Building Code, Building and that has an insured value of \$300,000 or more or, if the building is uninsured or for which documentation of insured value is not presented, has a just valuation for the structure for purposes of ad valorem taxation of \$300,000 or more:
- (a) Roof to wall connections shall be improved as required by section 201.3.
  - (b) Mandated retrofits of the roof-to-wall connection shall not be required beyond a 15 percent increase in the cost of re-roofing.
  - (c) Where complete retrofits of all the roof-to-wall connections as prescribed in Section 201.3 would exceed 15 percent of the cost of the re-roofing project, the priorities outlined in Section 201.3.75 shall be used to limit the scope of work to the 15 percent limit.
- 101.3** When any activity requiring a building permit that is applied for on or after July 1, 2008, and for which the estimated cost is \$50,000 or more for a building that is located in the wind borne debris region as defined in s. 1609.2 of the Florida Building Code, Building and that has an insured value of \$750,000 or more, or, if the building is uninsured or for which documentation of insured value is not presented, has a just valuation for the structure for purposes of ad valorem taxation of \$750,000 or more.:
- (a) Opening protections as required within the Florida Building Code, Building or Florida Building Code, Residential for new construction shall be provided.
- 101.4** When retrofit enhancement of gable end bracing is provided during construction which otherwise requires a permit the techniques in Appendix A shall be allowed.

**201 Roof System Mitigation Techniques.** Roof sheathing fastening, secondary water barriers, roof to wall connection and gable end bracing shall be permitted pursuant to this section.

**201.1 Roof sheathing fastening for site-built single family residential structures.** For site-built single family residential structures the fasteners and spacing required in Table

201.1 are deemed to comply with the requirements of Section 507.2.2, of the 2004 Florida Building Code, Existing Building.

Board roof decking secured with at least two 8d nails into roof framing members shall be deemed to be sufficiently connected. Board roof decking secured with smaller fasteners than 8d nails or with fewer than two 8d nails per board shall be deemed sufficiently connected if two 8d clipped head, round head, or ring shank nails are in place on each framing member.

Supplemental fasteners as required by Table 201.1 shall be 8d ring shank nails with round heads and the following minimum dimensions:

1. 0.113 inch nominal shank diameter
2. Ring diameter of 0.012 over shank diameter
3. 16 to 20 rings per inch
4. 0.280 inch full round head diameter
5. Ring shank to extend a minimum of 1 1/2" from the tip of the nail.
6. Minimum 2-1/4 inch nail length

**Table 201.1  
Supplement Fasteners at Panel Edges and Intermediate Framing**

<b>Existing fasteners</b>	<b>Existing spacing</b>	<b>Wind speed 110 mph or less supplemental fastening shall be no greater than</b>	<b>Wind speed greater than 110 mph supplemental fastening shall be no greater than</b>
Staples or 6d	Any	6" o.c. <sup>b</sup>	6" o.c. <sup>b</sup>
8d clipped head, round head, or ring shank	6" o.c. or less	None necessary	None necessary
8d clipped head, round head, or ring shank	Greater than 6" o.c.	6" o.c. <sup>a</sup>	6" o.c. <sup>b a</sup>

a. Maximum spacing determined based on existing fasteners and supplemental fasteners.

b. Maximum spacing determined based on supplemental fasteners only.

**201.2 Roof secondary water barrier for site-built single family residential structures.** A secondary water barrier shall be installed using one of the following methods when reroofing.

- a) All joints in structural panel roof sheathing or decking shall be covered with a minimum 4 in. wide strip of self-adhering polymer modified bitumen tape applied directly to the sheathing or decking. The deck and self adhering polymer modified bitumen tape shall be covered with one of the underlayment systems approved for the particular roof covering to be applied to the roof.

b) The entire roof deck shall be covered with an approved self-adhering polymer modified bitumen eap sheet. No additional underlayment shall be required on top of this eap sheet for new installations.

c) The entire roof deck shall be covered with an approved asphalt impregnated 30# felt underlayment installed with nails and tin-tabs as required for the HVHZ. **(No additional underlayment shall be required over the top of this sheet).**

d) Outside of the HVHZ, **an underlayment complying with section 1507.2.3 of the Florida Building Code, Building fastened as described below or** a layer of asphalt impregnated approved #30 felt shall be installed. The felt is to be fastened with 1” round plastic cap or metal cap nails, attached to a nailable deck in a grid pattern of 12 inches (305 mm) staggered between the overlaps, with 6-inch (152 mm) spacing at the overlaps. For slopes of 2:12 to 4:12 an additional layer of felt shall be installed in a shingle-fashion and lapped 19” and fastened as described above. **(No additional underlayment shall be required over the top of this sheet).**

**Exceptions:**

1. Roof slopes < 2:12 having a continuous roof system shall be deemed to comply with section 201.2 requirements for a secondary water barrier.
2. Clay and Concrete tile roof systems installed as required by the Florida Building Code are deemed to comply with the requirements of section 201.2 for Secondary Water Barriers.

**201.3 Roof-to-wall connections for site-built single family residential structures.**

Where required by Section 101.2, the intersection of roof framing with the wall below shall be strengthened by adding metal connectors, clips, straps, and fasteners such that the performance level equals or exceeds the uplift capacities as specified in Table 201.3. As an alternative to an engineered design, the prescriptive retrofit solutions provided in Sections 201.3.34 through 201.3.64 shall be accepted as meeting the mandated roof-to-wall retrofit requirements.

**Exceptions:**

1. Where it can be demonstrated (by code adoption date documentation and permit issuance date) that roof-to-wall connections and/or roof-to-foundation continuous load path requirements were required at the time of original construction.
2. Roof- to- wall connections shall not be required unless evaluation and installation of connections at gable ends or all corners can be completed for 15% of the cost of roof replacement.

**201.3.1 Access for Retrofitting Roof to Wall Connections.** These provisions are not intended to limit the means for gaining access to the structural elements of the roof and wall for the purposes of retrofitting the connection. The retrofit of roof to wall connections can be made by access through the area under the eave, from above through the roof, or from the interior of the house. Methods for above access include removal of roof panels or sections thereof or removal of portions of roof paneling at selected

locations large enough for access, viewing, and installing the retrofit connectors and fasteners.

Where panels or sections are removed, the removed portions shall not be reused. New paneling shall be used and fastened as in new construction.

**201.3.2 Partially inaccessible straps:** Where part of a strap is inaccessible, if the portion of the strap that is observed is fastened in compliance with these requirements, the inaccessible portion of the strap shall be presumed to comply with these requirements.

**201.3.31 Prescriptive method for gable roofs on a wood frame wall.** The anchorage of each of the exposed rafters or truss within 6 ft of the corner along the exterior wall on each side of each gable end shall be inspected. Wherever a strap is missing or an existing strap has fewer than four fasteners on each end, approved straps, ties or right angle gusset brackets with a minimum uplift capacity of 500 lbs shall be installed that connect each rafter or truss to the top plate below. Adding fasteners to existing straps shall be allowed in lieu of adding a new strap provided the strap is manufactured to accommodate at least 4 fasteners at each end. Wherever access makes it possible (without damage of the wall or soffit finishes), both top plate members shall be connected to the stud below using a stud to plate connector with a minimum uplift capacity of 500 lbs.

**201.3.42 Prescriptive method for gable roofs on a masonry wall.** The anchorage of each of the exposed rafters or truss within 6 ft of the corner along the exterior wall on each side of each gable end shall be inspected. Wherever a strap is missing or an existing strap has fewer than four fasteners on each end, approved straps, ties or right angle gusset brackets with a minimum uplift capacity of 500 lbs shall be installed that connect each rafter or truss to the top plate below or directly to the masonry wall using approved masonry screws that will provide at least a 2-1/2 embedment into the concrete or masonry. When the straps or right angle gusset brackets are attached to a wood sill plate, the sill plate shall be anchored to the concrete masonry wall below. This anchorage shall be accomplished by installing 1/4-inch diameter masonry screws, each with supplementary 1/4-inch washer, having sufficient length to develop a 2-1/2 inch embedment into the concrete and masonry. These screws shall be installed within 4-inches of the truss or rafter on both sides of each interior rafter or truss and on the accessible wall side of the gable end truss or rafter.

**201.3.53 Prescriptive method for hip roofs on a wood frame wall.** Unless it is possible to verify through non-destructive inspection or from plans prepared by a design professional that the roof structure is anchored at least as well as outlined below, access shall be provided at a minimum to the hip rafter (**commonly known as a “king jack”**), to the hip girder and at each corner of the hip roof. The hip rafter (**commonly known as a “king jack”**), the hip girder and the rafters/trusses adjacent to the hip girder that are not anchored with a strap having at least four fasteners on each end, shall be connected to the top plate below using a strap or a right angle gusset bracket having a minimum uplift capacity of 500 lbs. Adding fasteners to existing straps shall be allowed in lieu of adding a new strap provided the strap is manufactured to accommodate at least 4 fasteners at

each end. Wherever access makes it possible (without damage of the wall or soffit finishes), both top plate members shall be connected to the stud below using a stud to plate connector with a minimum uplift capacity of 500 lbs.

**201.3.64 Prescriptive method for hip roofs on a masonry wall.** Unless it is possible to verify through non-destructive inspection or from plans prepared by a design professional that the roof structure is anchored at least as well as outlined below, access shall be provided at a minimum to the hip rafter (**commonly known as a “king jack”**), to the hip girder and at each corner of the hip roof. The hip rafter (**commonly known as a “king jack”**), the hip girder and the rafters/trusses adjacent to the hip girder that are not anchored with a strap having at least four fasteners on each end, shall be connected to the concrete masonry wall below using approved straps or right angle gusset brackets with a minimum uplift capacity of 500 lbs. Adding fasteners to existing straps shall be allowed in lieu of adding a new strap provided the strap is manufactured to accommodate at least 4 fasteners at each end. The straps or right angle gusset brackets shall be installed such that they connect each rafter or truss to the top plate below or directly to the masonry wall using approved masonry screws that will provide at least a 2-1/2 embedment into the concrete or masonry. When the straps or right angle gusset brackets are attached to a wood sill plate, the sill plate shall be anchored to the concrete masonry wall below. This anchorage shall be accomplished by installing 1/4-inch diameter masonry screws, each with supplementary 1/4-inch washer, with sufficient length to develop a 2-1/2 inch embedment into the concrete and masonry. These screws shall be installed within 4-inches of the truss or rafter on both sides of each interior rafter or truss and on the accessible wall side of the gable end truss or rafter.

**201.3.75 Priorities for mandated roof-to-wall retrofit expenditures.** For houses with both hip and gable roof ends, the priority shall be to retrofit the gable end roof-to-wall connections unless the width of the hip end is more than 1.5 times greater than the width of the gable end. Priority shall be given to connecting the corners of roofs to walls below where the spans of the roofing members are greatest.

**Table 201.3  
REQUIRED UPLIFT CAPACITIES FOR ROOF-TO-WALL CONNECTIONS  
(POUNDS PER LINEAR FOOT)**

	BASIC WIND SPEED	ROOF SPAN (FEET)							OVERHANGS
		12	20	24	28	32	36	40	
Within 6 feet of building corner	85	-69.85	-116.42	-139.70	-162.99	-186.27	-209.55	-232.84	-27
	90	-82.67	-137.78	-165.34	-192.90	-220.45	-248.01	-275.57	-30.3
	100	-110.51	-184.18	-221.01	-257.85	-294.68	-331.52	-368.36	-37.4
	110	-141.27	-235.45	-282.55	-329.64	-376.73	-423.82	-470.91	-45.3
	120	-174.97	-291.62	-349.94	-408.26	-466.59	-524.91	-583.23	-53.9
	130	-211.60	-352.66	-423.19	-493.72	-564.26	-634.79	-705.32	-63.2
	140	-251.15	-418.59	-502.31	-586.02	-669.74	-753.46	-837.18	-73.3
	150	-293.64	-489.40	-587.28	-685.16	-783.04	-880.92	-978.80	-84.2
	170	-387.40	-645.67	-774.81	-903.94	-1033.08	-1162.21	-1291.35	-108
Greater than 6 ft from building corner	85	-39.10	-65.17	-78.20	-91.24	-104.27	-117.30	-130.34	-27
	90	-48.20	-80.33	-96.39	-112.46	-128.52	-144.59	-160.66	-30.3
	100	-67.95	-113.24	-135.89	-158.54	-181.19	-203.84	-226.49	-37.4
	110	-89.78	-149.63	-179.55	-209.48	-239.40	-269.33	-299.25	-45.3
	120	-113.68	-189.47	-227.37	-265.26	-303.16	-341.05	-378.94	-53.9
	130	-139.67	-232.78	-279.34	-325.90	-372.45	-419.01	-465.57	-63.2
	140	-167.74	-279.56	-335.47	-391.38	-447.29	-503.21	-559.12	-73.3
	150	-197.88	-329.80	-395.76	-461.72	-527.68	-593.64	-659.60	-84.2
	170	-264.41	-440.68	-528.81	-616.95	-705.08	-793.22	-881.35	-108

**Notes:**

- a. The required capacities are pounds per lineal foot of building length. For roof framing spaced at 16 inches on center multiply table values by 1.33. For roof framing spaced at 24 inches on center multiply table values by 2.
- b. The required capacities include an allowance for 10 pounds of dead load.
- c. The required capacities do not account for the effects of overhangs. The overhang loads given shall be multiplied by the overhang projection and added to the required capacities in the table.

## APPENDIX A

### GABLE END WALL BRACING RETROFIT

#### SECTION A101 GENERAL

**A101.1 Intent and purpose.** The provisions of this subsection provide prescriptive solutions for the retrofitting of gable ends of buildings. The retrofit measures are not intended to provide strengthening of buildings equal to the structural provisions of the latest building code requirements for new buildings. Design for compliance of new buildings and additions to existing buildings shall conform to the requirements of the Florida Building Code, Building or Florida Building Code, Residential as applicable.

**A101.2 Scope.** The following prescriptive methods are intended for applications where the gable end wall framing is provided by a wood gable end wall truss or a conventionally framed rafter system. The retrofits are appropriate for wall studs oriented with their broad face parallel to or perpendicular to the gable wall surface. An overview perspective drawing of the retrofit is shown in Figure A104.1.

#### SECTION A102 DEFINITIONS

**ANCHOR BLOCK.** A nominal 2-inch thick by at least 4" wide piece of lumber secured to horizontal braces and filling the gap between existing framing members for the purpose of restraining horizontal braces from movement perpendicular to the framing members.

**COMPRESSION BLOCK.** A nominal 2-inch thick by at least 4" wide piece of lumber used to restrain in the compression mode (force directed towards the interior of the attic) an existing or retrofit stud. It is attached to a horizontal brace and bears directly against the existing or retrofit stud.

**CONVENTIONALLY FRAMED GABLE END.** A conventionally framed gable end with studs whose faces are perpendicular to the gable end wall.

**HORIZONTAL BRACE.** A nominal 2-inch thick by at least 4" wide piece of lumber used to restrain both compression and tension loads applied by a retrofit stud. It is typically installed horizontally on the top of floor framing members (truss bottom chords or ceiling joists) or on the bottom of pitched roof framing members (truss top chord or rafters).

**RETROFIT STUD.** A nominal 2-inch lumber member used to structurally supplement an existing gable end wall stud.

**RIGHT ANGLE GUSSET BRACKET.** A 14 gage or thicker metal right angle bracket with a minimum load capacity perpendicular to the plane of either face of 350 lbs when connected to wood or concrete with manufacturer specified connectors.

**STUD-TO-PLATE CONNECTOR.** A manufactured metal connector designed to connect studs to plates with a minimum uplift capacity of 500 lbs.

**TRUSS GABLE END.** An engineered factory made truss or site built truss that incorporates factory installed or field installed vertical studs with their faces parallel to the plane of the truss and are spaced no greater than 24-inches on center. Web or other diagonal members other than top chords may or may not be present. Gable end trusses may be of the same height as nearby trusses or may be drop chord trusses in which the top chord of the truss is lower by the depth of the top chord or outlookers.

## **SECTION A103 MATERIALS OF CONSTRUCTION**

**A103.1 Existing materials.** All existing wood materials that will be part of the retrofitting work (trusses, rafters, ceiling joists, top plates, wall studs, etc.) shall be in sound condition and free from defects or damage that substantially reduce the load-carrying capacity of the member. Any wood materials found to be damaged or deteriorated shall be strengthened or replaced with new materials to provide a net dimension of sound wood equivalent to its undamaged original dimensions.

**A103.2 New Materials.** All materials approved by this code, including their appropriate allowable stresses, shall be permitted to meet the requirements of this chapter.

**A103.3 Dimensional Lumber.** All dimensional lumber for braces, studs, and blocking shall conform to applicable standards or grading rules. Dimensional lumber shall be identified by a grade mark of a lumber grading or inspection agency that has been approved by an accreditation body that complies with DOC PS 20. All new dimensional lumber to be used for retrofitting purposes shall be a minimum grade and species of #2 Spruce-Pine-Fir or shall have a specific gravity of 0.42 or greater. In lieu of a grade mark, a certificate of inspection issued by a lumber grading or inspection agency meeting the requirements of this code shall be accepted.

**A103.4 Metal Plate Connectors, Straps and Anchors.** Metal plate connectors, straps and anchors shall have product approval. They shall be approved for connecting wood-to-wood or wood-to-concrete as appropriate. Straps and tie plates shall be manufactured from galvanized steel with a minimum thickness provided by 20 gauge. Tie plates shall have holes sized for 8d nails.



**A103.5 Twists in straps.** Straps shall be permitted to be twisted 90 degrees in addition to a 90 degree bend where they transition between framing members or connection points.

**A103.6 Fasteners.** Fasteners meeting the requirements of Sections A103.6.1 and A103.6.2 shall be used and shall be permitted to be screws or nails meeting the minimum length requirement shown in figures and specified in tables.

**A103.6.1 Screws.** Screws shall be a minimum #8 size with head diameters no less than 0.3 inch. Screw lengths shall be no less than indicated in the Figures and in Tables. Permissible screws include deck screws, wood screws, or sheet metal screws (without drill bit type tip, but can be sharp pointed). Screws shall have at least 1 inch of thread. Fine threaded screws or drywall screws shall not be permitted. Note that many straps will not accommodate screws larger than #8.

**A103.6.2 Nails.** Unless otherwise indicated in the provisions or drawings, where fastener lengths are indicated in Figures and Tables as 1-1/4 inch, 8d common nails with shank diameter 0.131 inch and head diameters no less than 0.3 inch shall be permitted. Unless otherwise indicated in the provisions or drawings, where fasteners lengths are indicated in Figures and Tables as 3 inch, 10d common nails with shank diameter of 0.148 inch and head diameters no less than 0.3 inch shall be permitted.

**A103.7 Fastener spacing.** Fastener spacing shall be as follows:

- a) distance between fasteners and the edge of lumber shall be a minimum of 1/2 inch unless otherwise indicated,
- b) distance between fasteners and the end of lumber shall be a minimum of 2-1/2 inch,
- c) distance between fasteners parallel to grain (center-to-center) when straps are not used shall be a minimum of 2-1/2 inches unless a 1/2-inch stagger (perpendicular to the grain) is applied for adjacent fasteners, then the distance between fasteners parallel to the grain shall be a minimum of 1-1/4 inches.
- d). distance between fasteners across grain (row spacing) when straps are not used shall be a minimum of 1 inch, and the
- e) distance between fasteners inserted in metal plate connectors, straps and anchors as defined in Section A103.4 shall be those provided by holes manufactured into the straps.

## **SECTION A104 RETROFITTING GABLE END WALLS**

**A104.1 Scope and intent.** Gable ends to be strengthened shall be permitted to be retrofitted using methods prescribed by provisions of this section. These prescriptive methods of retrofitting are intended to increase the resistance of existing gable end wall construction for out-of-plane wind loads resulting from high wind events. The retrofit method addresses four issues. These include strengthening the framing members of the

walls if necessary (retrofit studs), bracing the top and bottom of the gable wall so that lateral loads are transmitted into the roof and ceiling diaphragms (horizontal braces, straps to retrofit studs and compression blocks) and connecting the bottom of the gable end wall to the wall below to help brace the top of that wall (specialty metal brackets).

The following prescriptive methods are intended for applications where the gable end wall framing is provided by a wood gable end wall truss or a conventionally framed rafter system. The retrofits are appropriate for wall studs oriented with their broad face parallel to or perpendicular to the gable wall surface. An overview perspective drawing of the retrofit is shown in Figure A104.1.

**A104.2 Horizontal Braces.** Horizontal braces shall be installed approximately perpendicular to the top and bottom chords of the existing roof trusses or approximately perpendicular to the rafters and ceiling joists at the location of each existing gable end wall stud greater than 3-feet in length. If the spacing of existing gable end studs is greater than 24 inches or no vertical gable end stud is present, a stud and horizontal braces shall be installed such that the maximum spacing between existing and added studs shall be 24-inches. Additional gable end wall studs shall not be required at locations where their length would be 3-feet or less. Each required added stud shall be attached to the existing roofing framing members (truss top chord or rafter and truss bottom chord or ceiling joist) using a minimum of two 3-inch toenail fasteners (#8 wood screws or 10d nails) and a metal connector or mending plate with a minimum of four 1-1/4 inch long fasteners (#8 wood screws or 8d nails) at each end. The horizontal braces shall consist of the minimum size member indicated in Table A104.2. The horizontal brace shall be oriented with their long face across the top and bottom chords of the wood trusses (or rafters and ceiling joists) and extend a minimum of three framing spacings from the gable end wall plus 2-1/2 inch beyond the last top chord or bottom chord member (rafter or ceiling joist) as shown in Figure A104.2.1 (and A104.2.6). The horizontal brace shall be located no farther than 1/2 inch from the inside face of the gable end wall truss. Each horizontal brace shall be fastened to each existing framing member (top chord or rafter or bottom chord or ceiling joist) that it crosses using three 3-inch long fasteners (#8 wood screws or 10d nails) as indicated in Figures A104.2.2 through A104.2.5 for trusses (and Figures A104.2.7 through A104.2.10 for rafters).

**Exceptions:**

1. Where obstructions, other permanently attached obstacles or conditions exist that will not permit installation of new horizontal braces at the indicated locations, refer to Section A104.5 for permitted modification of these prescriptive retrofit methods.
2. Where obstructions, other permanently attached obstacles or conditions exist that will not permit extension of the new horizontal braces across the existing framing members a minimum of three framing spaces from the gable end wall, the horizontal braces may be shortened provided that all of the following conditions are met.

- a. The horizontal brace shall be installed across a minimum of two framing spaces and fastened to each existing framing member with three 3-inch long fasteners (#8 wood screws or 10d nails).
- b. The minimum size of the anchor block shall be equivalent to the existing framing members. The anchor block shall be fastened to the side of the horizontal brace in the second framing space from the gable end wall as shown in Figure A104.2.11. Six 3-inch long fasteners (#8 wood screws or 10d nails) shall be used to fasten the anchor block to the side of the horizontal brace.
- c. The anchor block shall extend beyond the surface of the horizontal brace that is in contact with the existing framing members a minimum of one-half the depth of the existing framing member. The anchor block shall be installed tightly between the existing framing members such that the gap at either end shall not exceed  $\frac{1}{8}$  inch.

**A104.3 Retrofit Studs.** The retrofit studs shall consist of the minimum size members for the height ranges of the existing vertical gable end wall studs indicated in Table A104.2. Retrofit studs shall be installed adjacent to the existing or added (Section A104.2) vertical gable end wall studs and extend from the top of the lower horizontal brace to the bottom of the upper horizontal brace. A maximum gap of 1/8-inch shall be permitted between the retrofit stud and the bottom horizontal brace. A maximum gap of 1/2-inch shall be permitted between the top edge of the retrofit stud closest to the upper horizontal brace and the horizontal brace surface.

**Exception:**

Where obstructions, other permanently attached obstacles or conditions exist that will not permit the installation of a new retrofit stud adjacent to an existing gable end wall stud, refer to Section A104.5 for permitted modification of these prescriptive retrofit methods.

**A104.3.1 Retrofit Stud Fastening.** Each retrofit stud shall be fastened to the top and bottom horizontal brace members with a minimum of a 20 gauge,  $1\frac{1}{4}$  inch wide flat metal strap with pre-punched fastener holes. The flat metal straps shall be the minimum length as indicated in Table A104.2. Each top and bottom strap shall extend sufficient distance onto the vertical face of the retrofit stud and be fastened with the number of  $1\frac{1}{4}$  inch long fasteners (#8 wood screws or 8d nails) indicated in Table A104.2. Each strap shall be fastened to the top and bottom horizontal brace members with the minimum number of  $1\frac{1}{4}$  inch long fasteners (#8 wood screws or 8d nails) as indicated in Table A104.2. The retrofit stud members shall also be fastened to the side of the existing vertical gable end wall studs with 3-inch long fasteners (#8 wood screws or 10d nails) spaced at 6-inches on center as shown in Figure A104.2.1.

**A104.3.2 Retrofit Stud Splices.** Retrofit studs greater than 8-feet in height may be field spliced as shown in Figure A104.3.

**A104.4 Compression Blocks.** Compression blocks shall have minimum lengths as indicated in Table A104.2. Compression blocks shall be installed on the horizontal braces directly against either the existing vertical gable end wall stud or the retrofit stud. For clarity, Figures A104.2.2 through A104.2.5 (trusses) and Figures A104.2.7 through A104.2.10 (rafters) show the installation of the compression block against the existing vertical gable end wall stud with the strap from the retrofit stud running beside the compression block. When the compression block is installed against the retrofit stud, the block shall be allowed to be placed on top of the strap. A maximum gap between the compression block and the existing vertical gable end wall stud member or retrofit stud of  $\frac{1}{8}$  inch shall be permitted. Compression blocks shall be fastened to the horizontal braces with the minimum number of 3-inch long fasteners (#8 wood screws or 10d nails). End and edge distances for fastener installation shall be as listed in Section A103.7 and shown in Figures A104.2.2 through A104.2.5 (trusses) and Figures A104.2.7 through A104.2.10 (rafters).

**A104.5 Obstructions – Permissible modifications to prescriptive gable end retrofits.** Where obstructions, other permanently attached obstacles or conditions exist in attics that preclude the installation of a retrofit stud or horizontal braces in accordance with Sections A104.2 or A104.3, the gable end retrofit shall be deemed to meet the requirements of this section if the requirements of Section A104.5.1 are met. Obstructions to the installation of retrofit studs or horizontal braces include gable end vents, attic accesses, recessed lights, skylight shafts, chimneys, air conditioning ducts, or equipment. Where the installation of a horizontal brace for the top of a center stud is obstructed by truss plates near the roof peak, methods prescribed in A104.5.1 are permitted to be used, or retrofit ridge ties as prescribed in Section A104.5.2 are permitted to be used to support the horizontal brace.

**A104.5.1 Remedial measures where obstacles prevent installation of retrofit studs or horizontal braces.** If a retrofit stud or horizontal brace cannot be installed because of an obstruction, the entire assembly can be omitted from that location provided all of the following conditions are met.

1. No more than two assemblies of retrofit studs and horizontal braces are omitted on a single gable end.
2. There shall be at least two retrofit studs and horizontal brace assemblies on either side of the locations where the retrofit studs and horizontal bracing members are omitted (no two ladder braces bearing on a single retrofit stud).
3. The retrofit studs on each side of the omitted retrofit stud are increased to the next indicated member size in Table A104.2 and fastened as indicated in Section A104.3.1.

4. The horizontal bracing members on each side of the omitted brace shall be sized in accordance with Table A104.2 for the required retrofit studs at these locations.
5. The horizontal bracing members on each side of the omitted brace shall extend a minimum of three framing spaces from the gable end wall unless anchor blocks are installed in accordance with Exception 2 of Section A104.2.
6. Ladder bracing is provided across the location of the omitted retrofit studs as indicated in Figures A104.5.1.1 (trusses) and A104.5.1.2 (rafters).
7. Ladder bracing shall consist of a minimum 2x4 members oriented horizontally and spaced at 12-inches on center vertically. Ladder bracing shall be attached to each adjacent retrofit stud with a metal framing angle with a minimum lateral capacity of 175 lbs. Ladder bracing shall be attached to the existing stud at the location of the omitted retrofit stud with a metal hurricane tie with a minimum capacity of 175 lbs.
8. Where ladder bracing spans across a gable end vent, no attachment to the gable end vent framing shall be required.
9. Notching of the ladder bracing shall not be permitted.

**A104.5.2 Retrofit ridge ties.** When obstructions along the ridge of the roof obstruct the installation of a horizontal brace for one or more studs near the middle of the gable wall, retrofit ridge ties may be used to provide support for the required horizontal brace. Retrofit ridge tie members shall be installed a maximum of 12 inches below the existing ridge line. The retrofit ridge tie members shall be installed across a minimum of three bays to permit fastening of the horizontal brace. A minimum of a 2x4 member shall be used for each ridge tie and fastening shall consist of two 3-inch long wood screws, four 3-inch long 10d nails or two 3-1/2 inch long 16d nails driven through and clinched at each top chord or web member intersected by the ridge tie as illustrated in Figure A104.5.2.

**A104.5.3 Notching of retrofit studs.** Retrofit studs may be notched in one location along the height of the stud member provided that all of the following conditions are met.

1. The retrofit stud to be notched shall be sized such that the remaining depth of the member at the location of the notch (including cut lines) shall not be less than that required by Table A104.2.
2. The notched retrofit stud shall not be spliced within 12 inches of the location of the notch. The splicing member shall not be notched and shall be installed as indicated in Figure A104.3.

3. The length of the flat metal straps indicated in Table A104.2 shall be increased by the increased depth of the notched retrofit stud member to be installed.

4. The height of the notch shall not exceed 12 inches vertically as measured at the depth of the notch.

5. The notched retrofit stud member shall be fastened to the side of the existing gable end wall studs in accordance with Section A104.3.1. Two additional 3-inch fasteners (#8 wood screws or 10d nails) shall be installed on each side of the notch in addition to those required by Section A104.3.1.

**A104.6 Connection of gable end wall to wall below.** The bottom chords or bottom members of wood framed gable end walls shall be attached to the wall below using one of the methods prescribed in Sections A104.6.1 or A104.6.2. The particular method chosen shall correspond to the framing system and type of wall construction encountered. Due to access considerations, this retrofit needs to be carried out before any of the other gable end retrofit activities referenced in Sections A104.2, A104.3, A104.4 or A104.5.

**A104.6.1 Truss gable end wall.** The bottom chords of the gable end wall shall be attached to the wall below using right angle gusset brackets consisting of 14 gage or thicker material with a minimum load capacity of 350 lbs perpendicular to the plane of either face of the connector. The right angle gusset brackets shall be installed throughout the portion of the gable end where the gable end wall height is greater than 3 feet at the spacing specified in Table A104.6. A minimum of two of the fasteners specified by the manufacturer shall engage the body of the bottom chord. Connection to the wall below shall be by one of the methods listed below:

1. For a wood frame wall below, the two fasteners into the top of the wall below that are closest to the face of the gable end bottom chord shall be 4-1/2 inches long and of the same diameter and style specified by the bracket manufacturer. Other fasteners shall be consistent with the bracket manufacturer's specifications for size, style and length.

2. For a concrete or masonry wall below without a sill plate, the fasteners into the wall shall be consistent with the bracket manufacturer's specifications for fasteners installed in concrete or masonry.

3. For a concrete or masonry wall below with a 2x sill plate, the fasteners into the wall below shall be of the diameter and style specified by the bracket manufacturer for concrete or masonry connections; but, long enough to pass through the wood sill plate and provide the required embedment into the concrete or masonry below. Alternatively, the bracket can be anchored to the sill plate using fasteners consistent with the bracket manufacturer's specifications for wood connections provided, the sill plate is anchored to the wall on each side of the bracket by a 1/4-inch diameter masonry screw with a 2-1/2 inch embedment into the concrete or masonry wall. 1/4-inch washers shall be placed under the heads of the masonry screws.

**A104.6.2 Conventionally framed gable end wall.** Each stud in a conventionally framed gable end wall, throughout the length of the gable end wall where the wall height is greater than 3-feet, shall be attached to the bottom or sill plate using a stud to plate connector. The bottom or sill plate shall then be connected to the wall below using one of the methods listed below:

1. For a wood frame wall below, the sill or bottom plate shall be connected to the top plates below using  $\frac{1}{4}$ -inch diameter screws 4-1/2 inches long. The fasteners shall be installed at the spacing indicated in Table A104.6.
2. For a concrete or masonry wall below, the sill or bottom plate shall be connected to the concrete or masonry wall below using  $\frac{1}{4}$ -inch diameter concrete or masonry screws of sufficient length to provide a 2-1/2 inch embedment into the top of the concrete or masonry wall. The fasteners shall be installed at the spacing indicated in Table A104.6.

The top chord of the gable end truss may be  $3\frac{1}{2}$ " or more lower than the other that of regular trusses to accommodate outlookers.

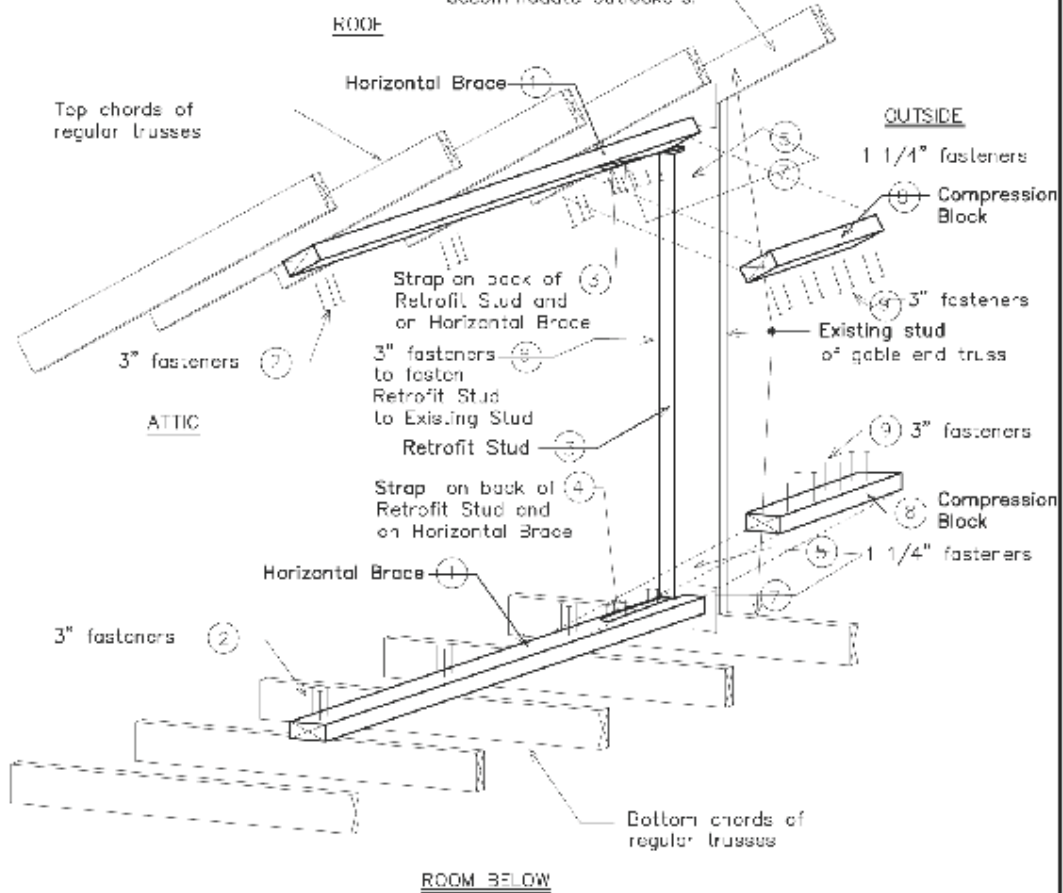

The gable end shown is a truss gable end. Similar retrofit measures apply to conventionally framed gable ends.

Regular trusses may have diagonal members that connect the bottom and top chords.

Fasteners shown illustrate locations and not the number of fasteners.

**FIGURE A104.1**  
**RETROFIT DETAILS FOR TRUSS GABLE ENDS**



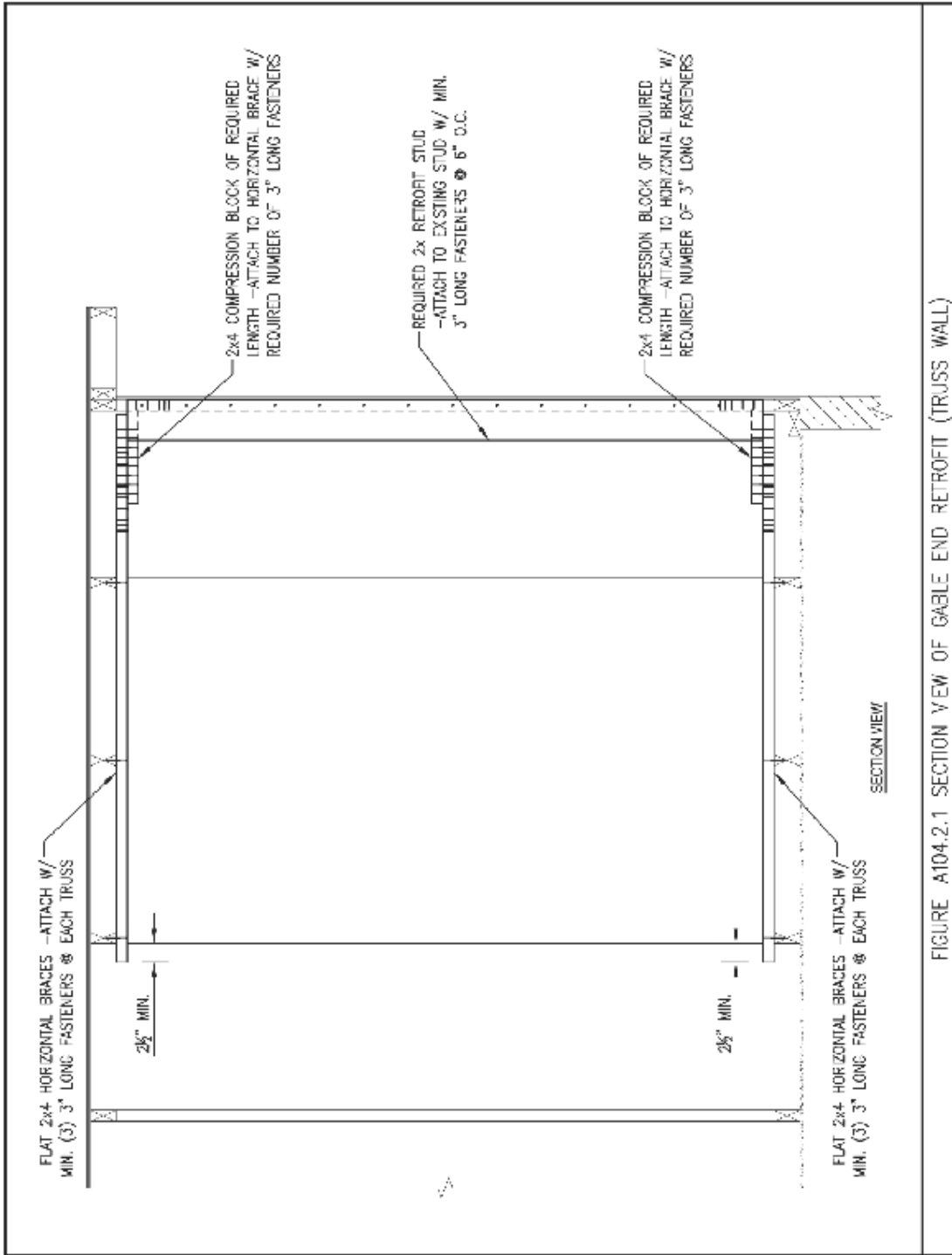
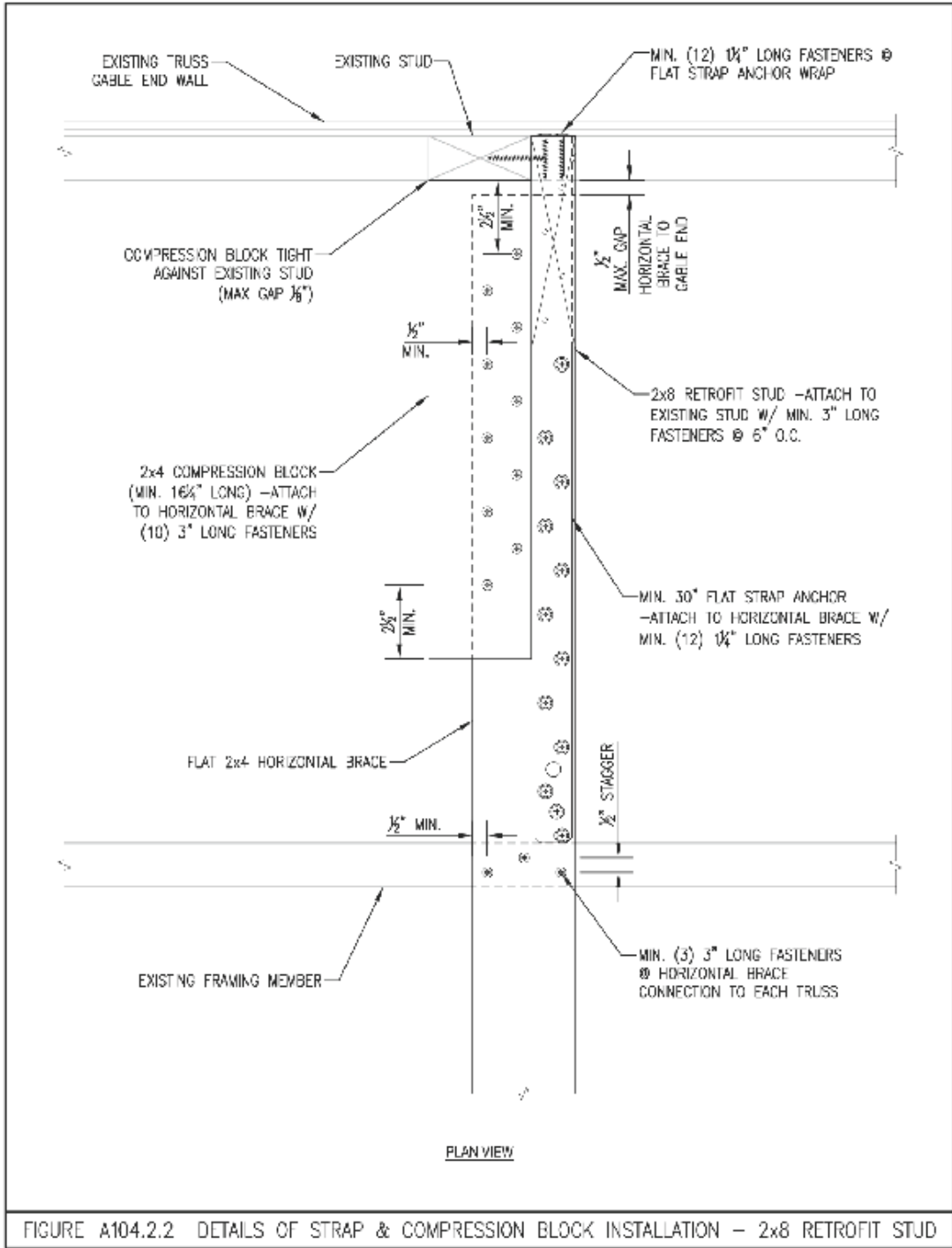
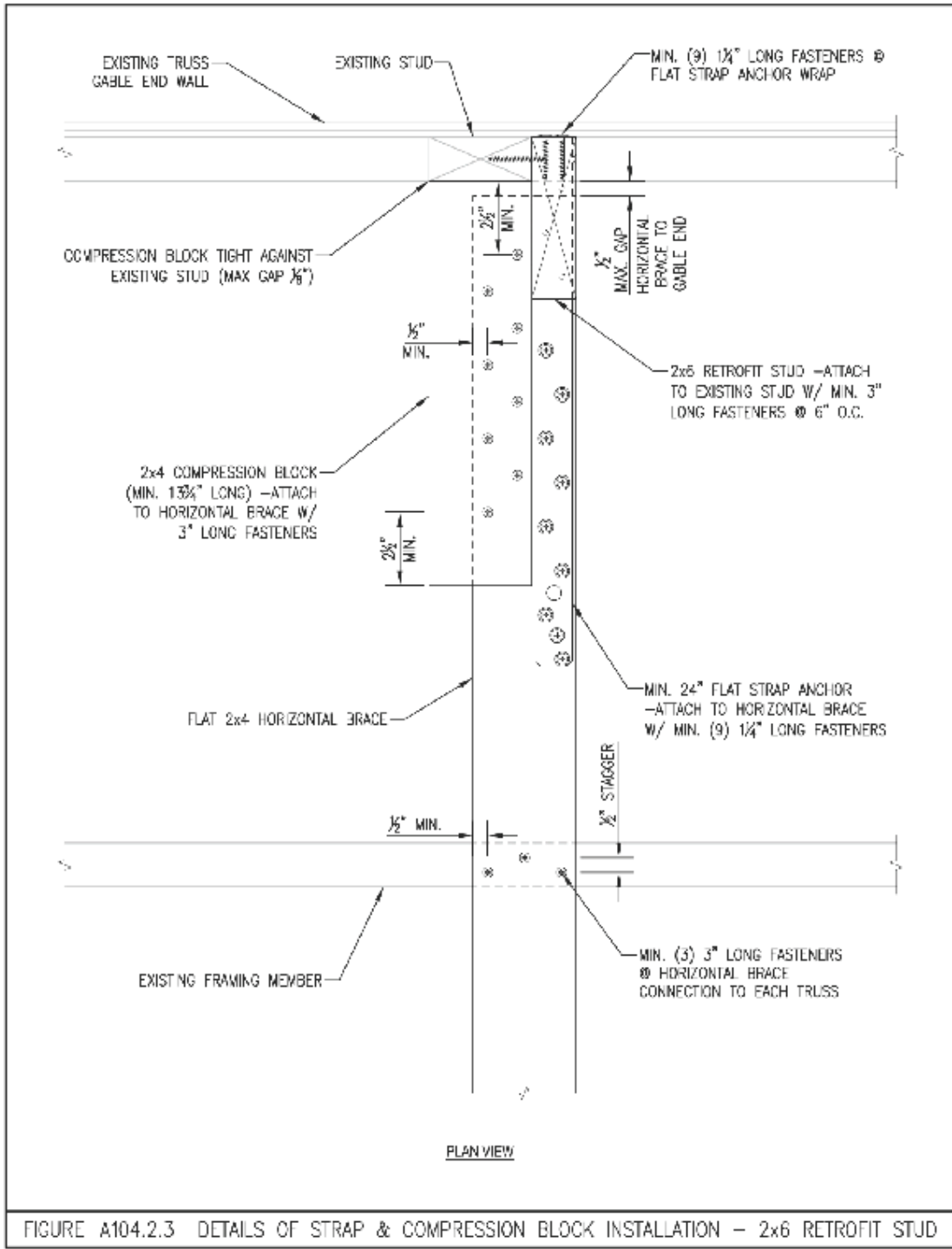
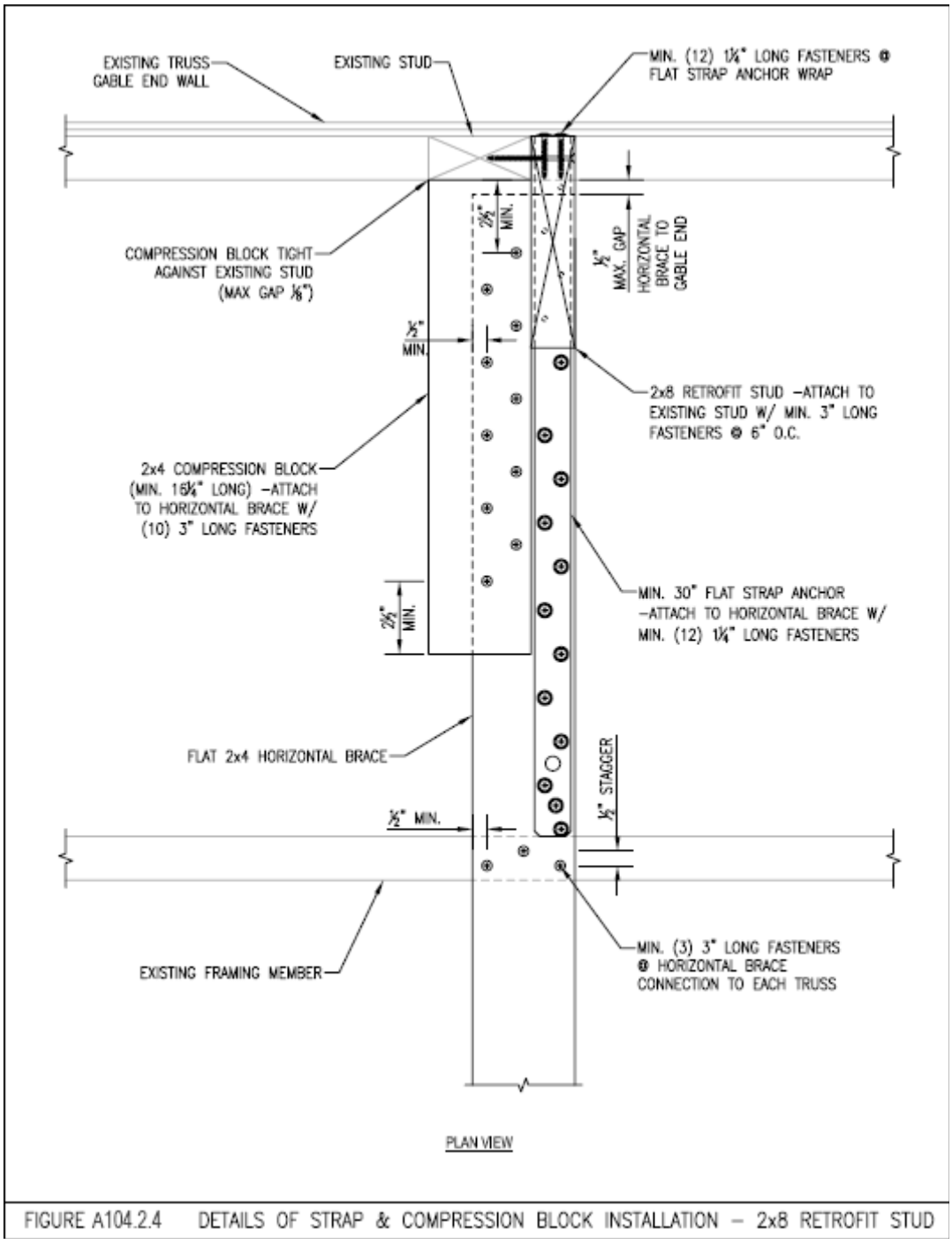
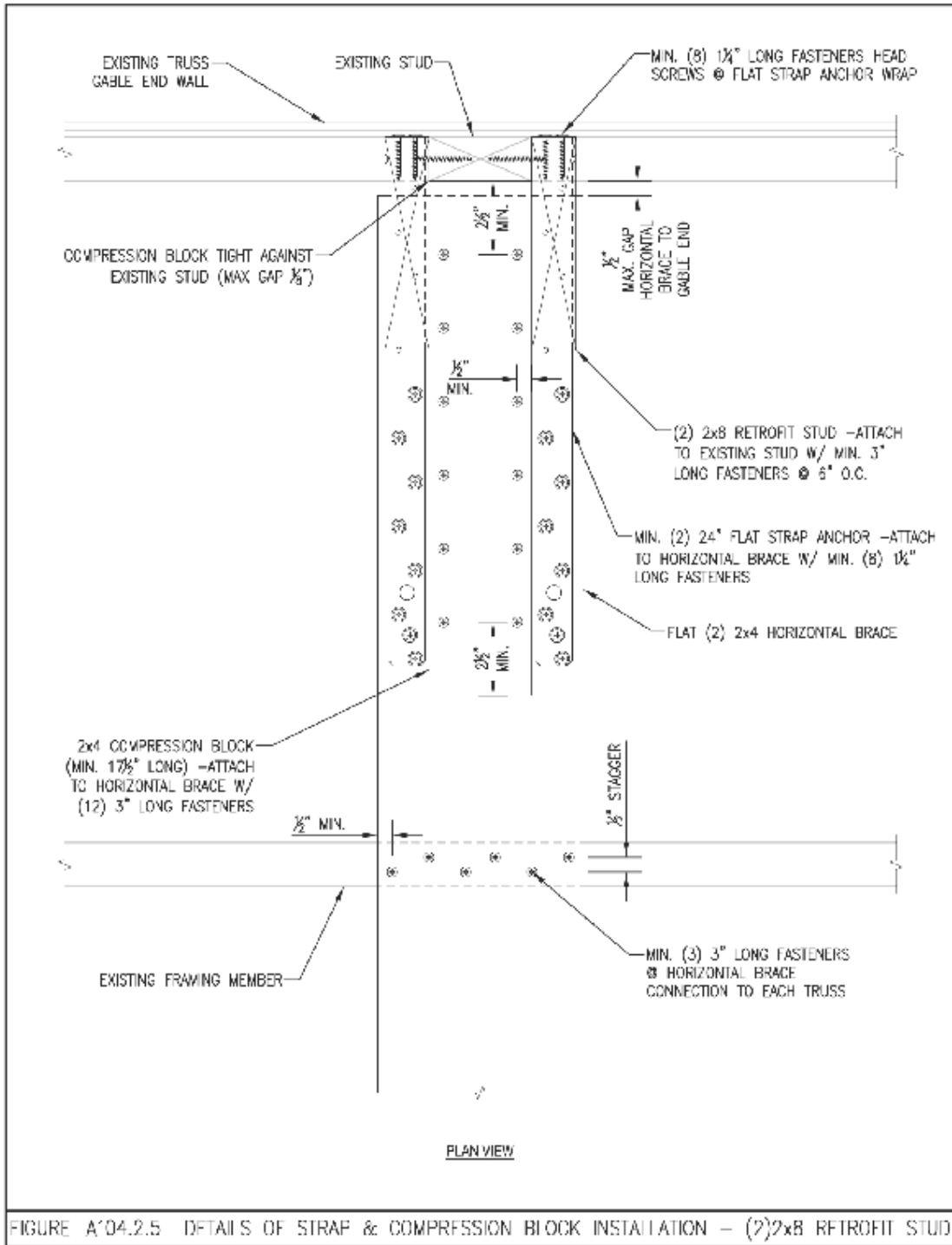

FIGURE A104.2.1 SECTION VIEW OF GABLE END RETROFIT (TRUSS WALL)









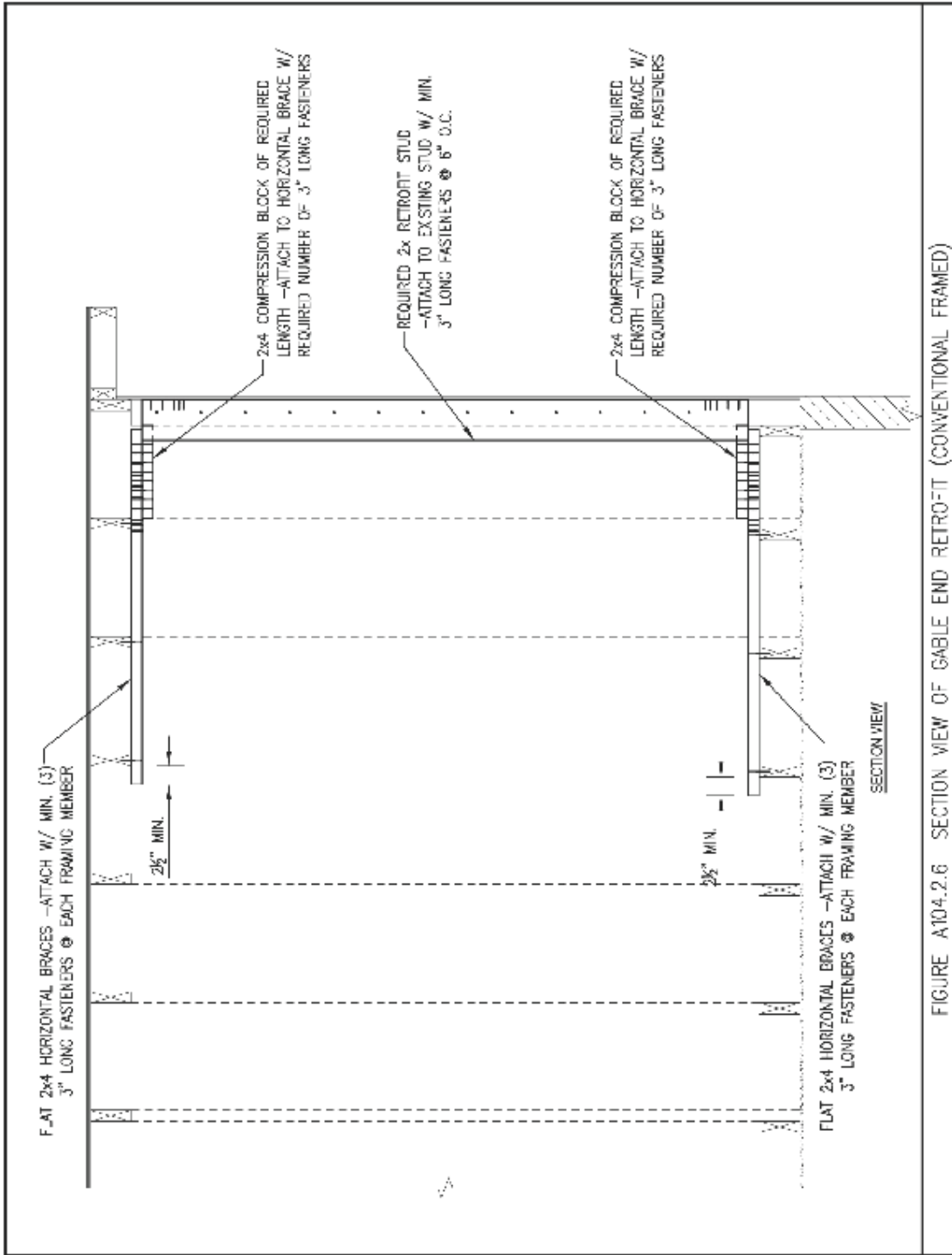
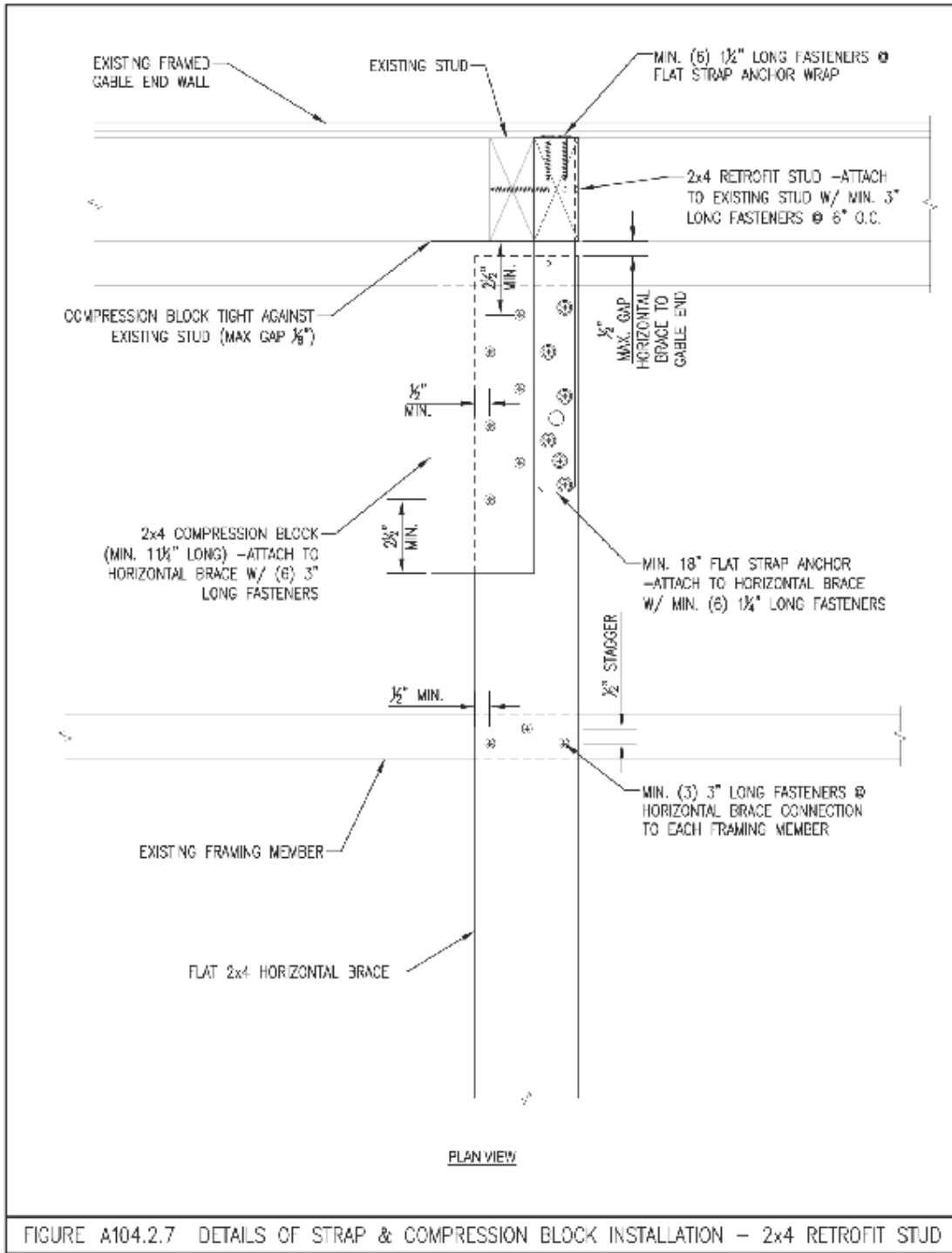
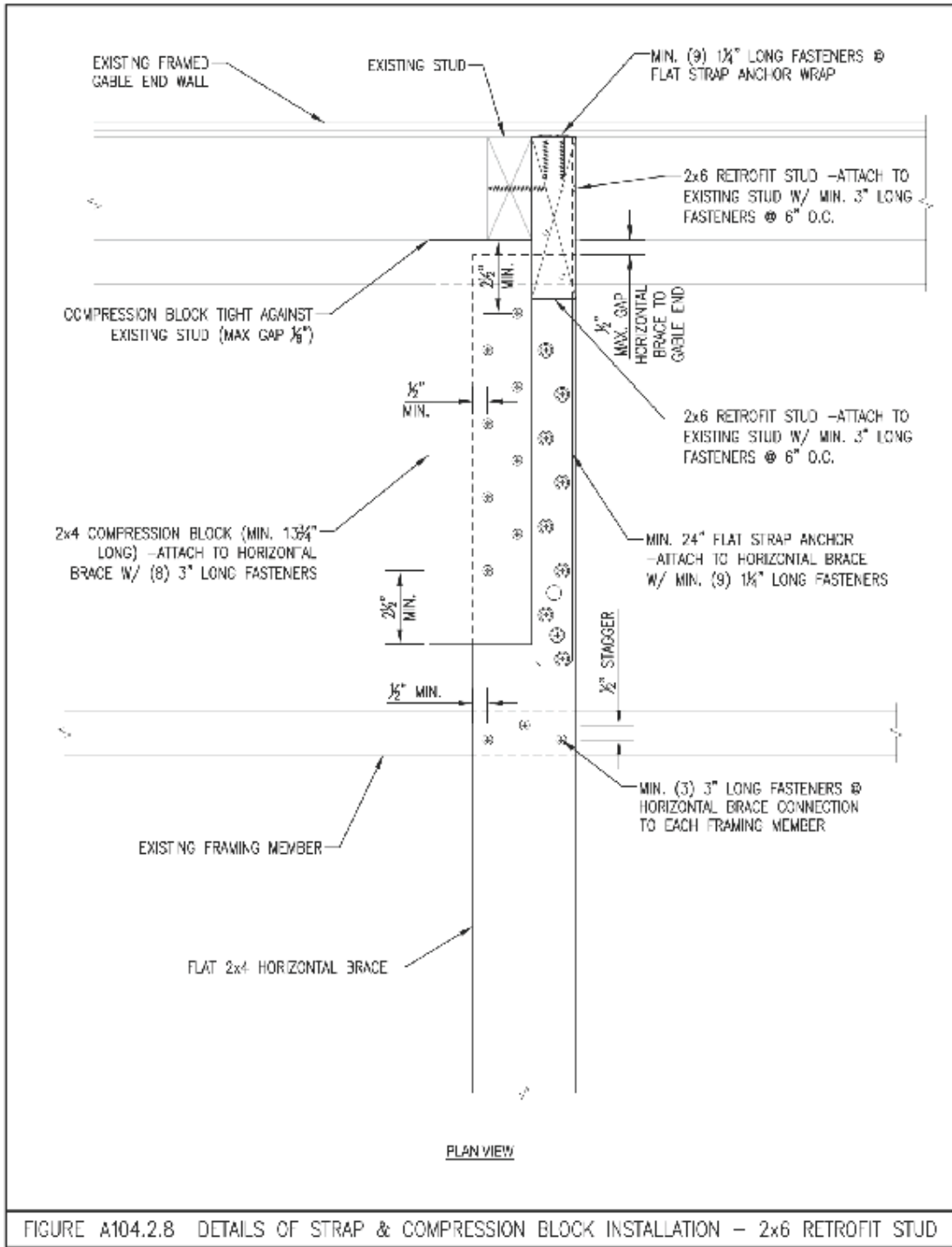
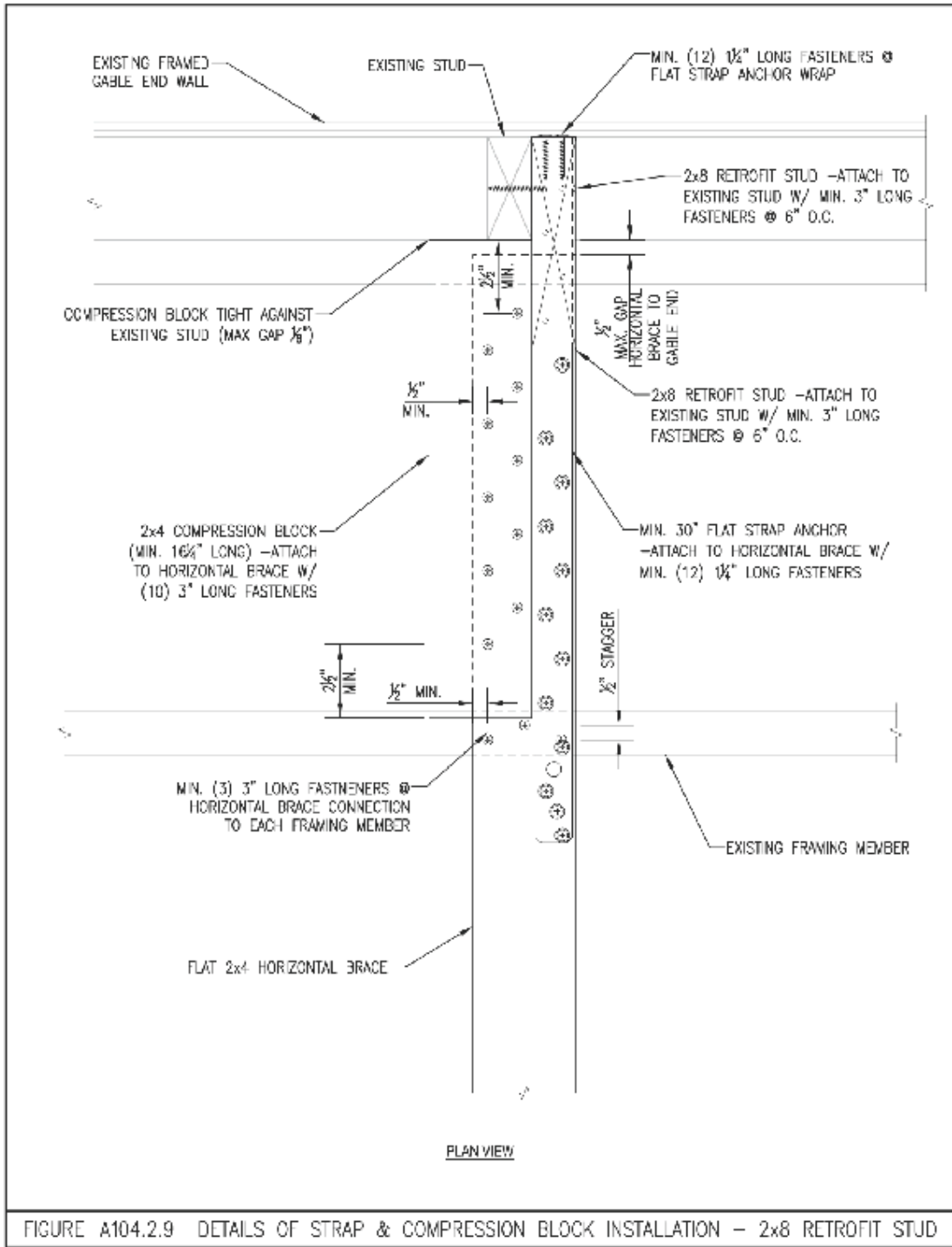

FIGURE A104.2.6 SECTION VIEW OF GABLE END RETROFIT (CONVENTIONAL FRAMED)









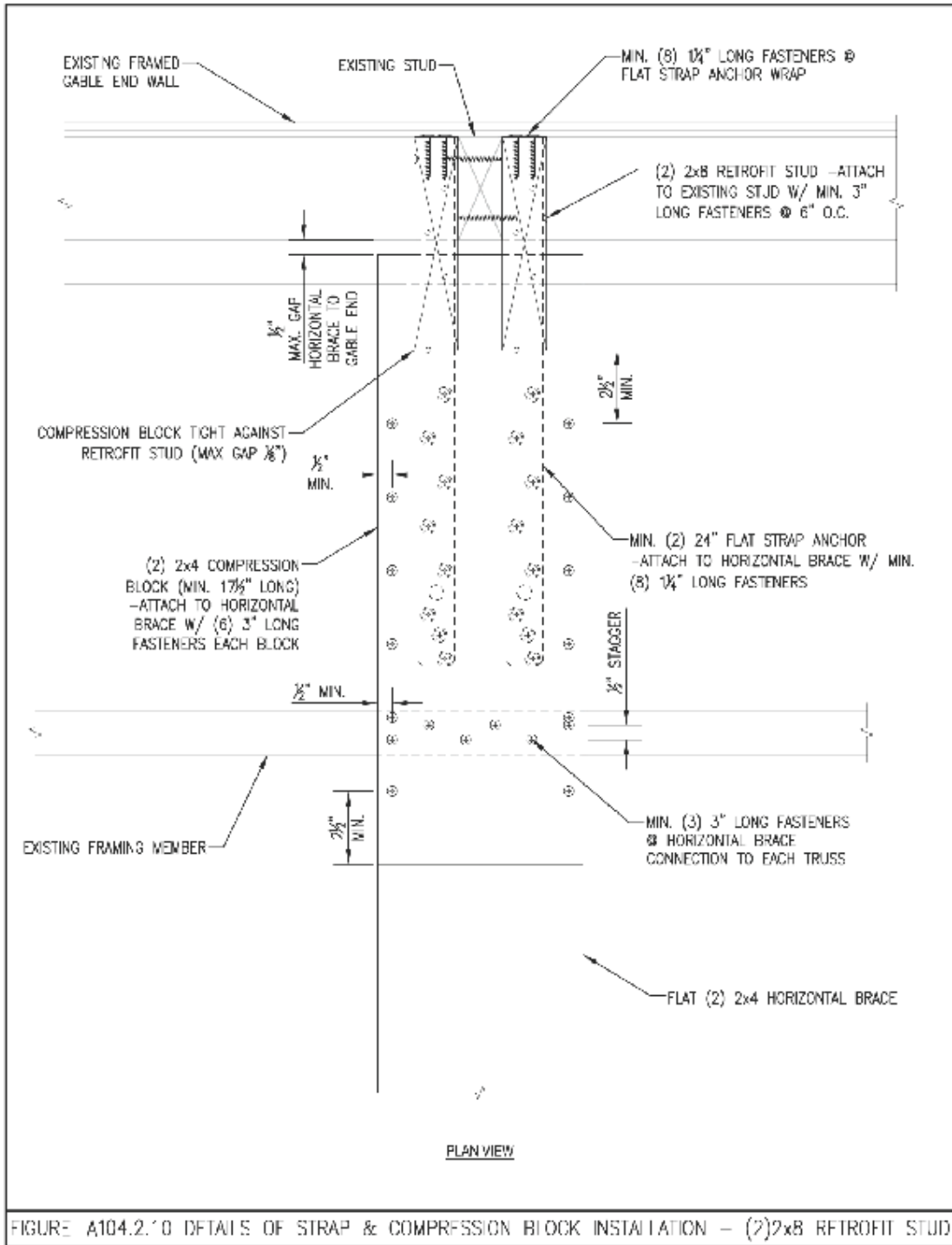

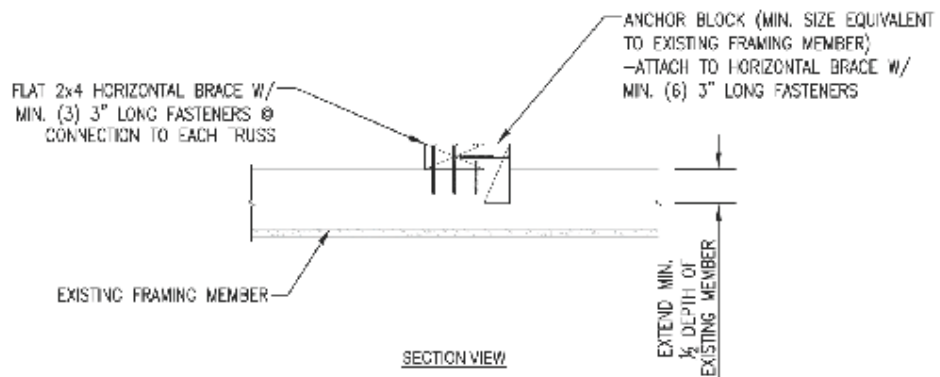
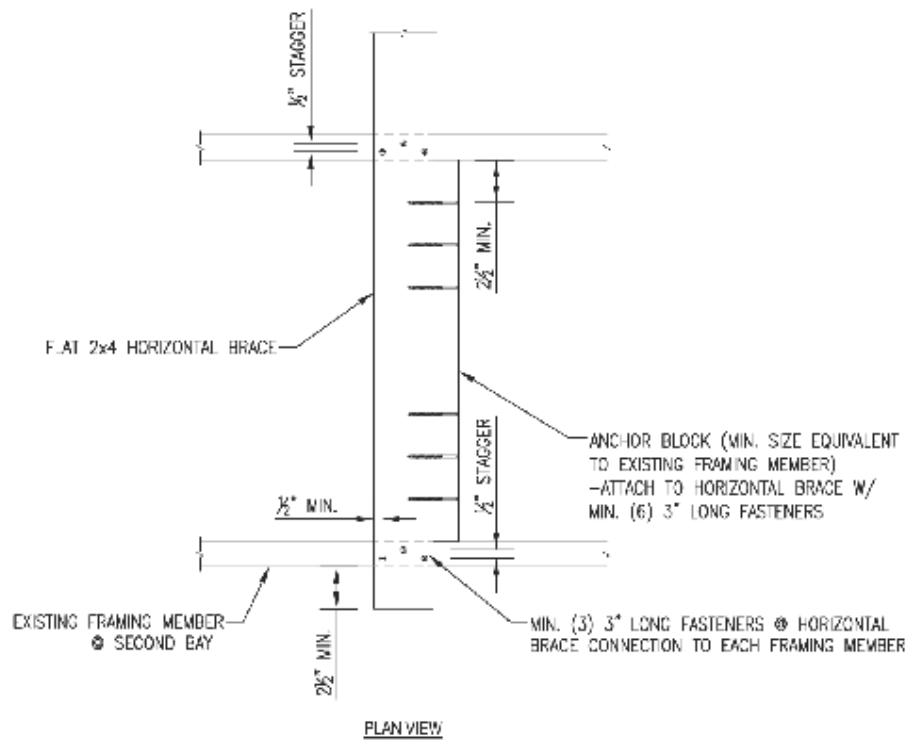
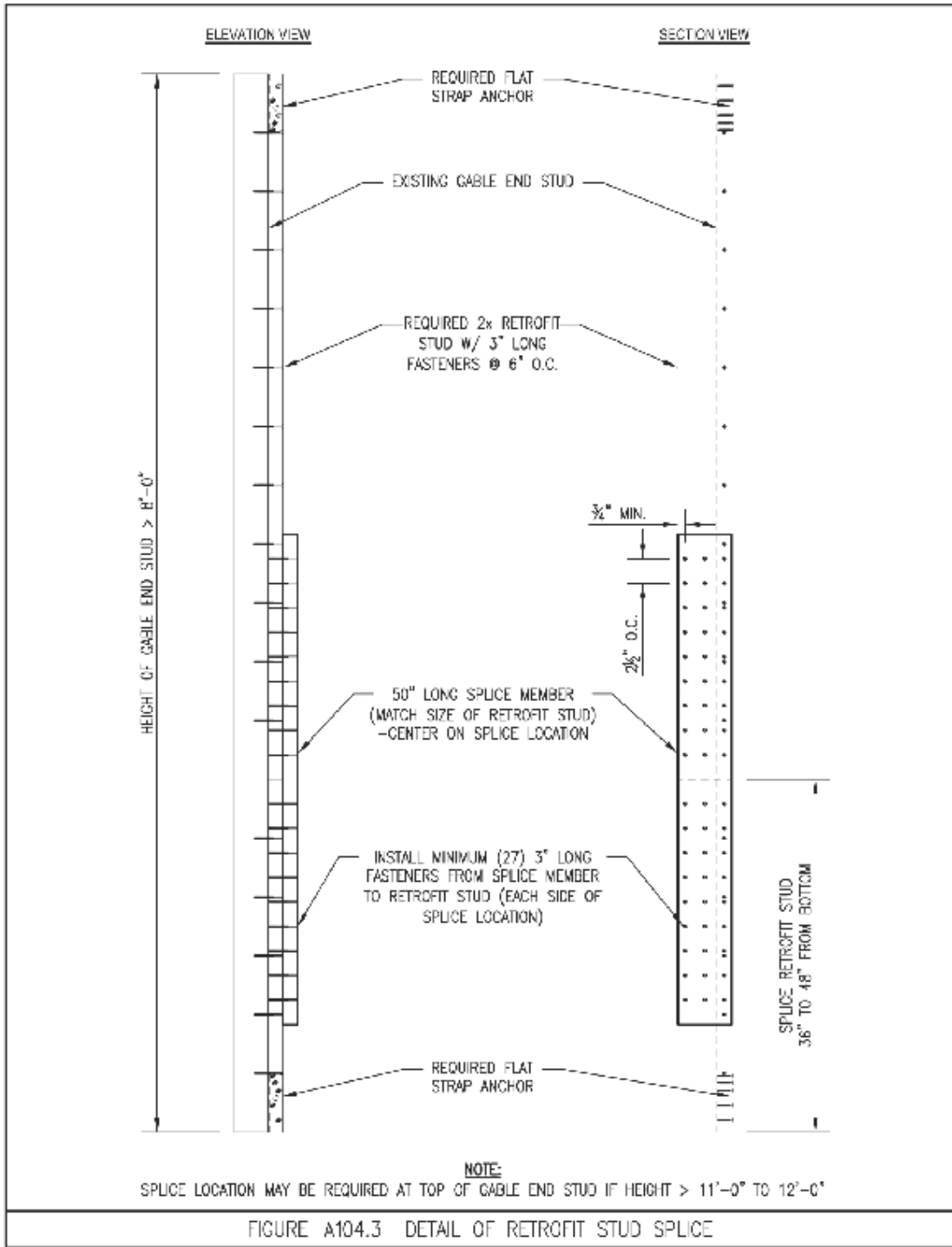

FIGURE A'04.2.11 DETAIL OF ANCHOR BLOCK INSTALLATION



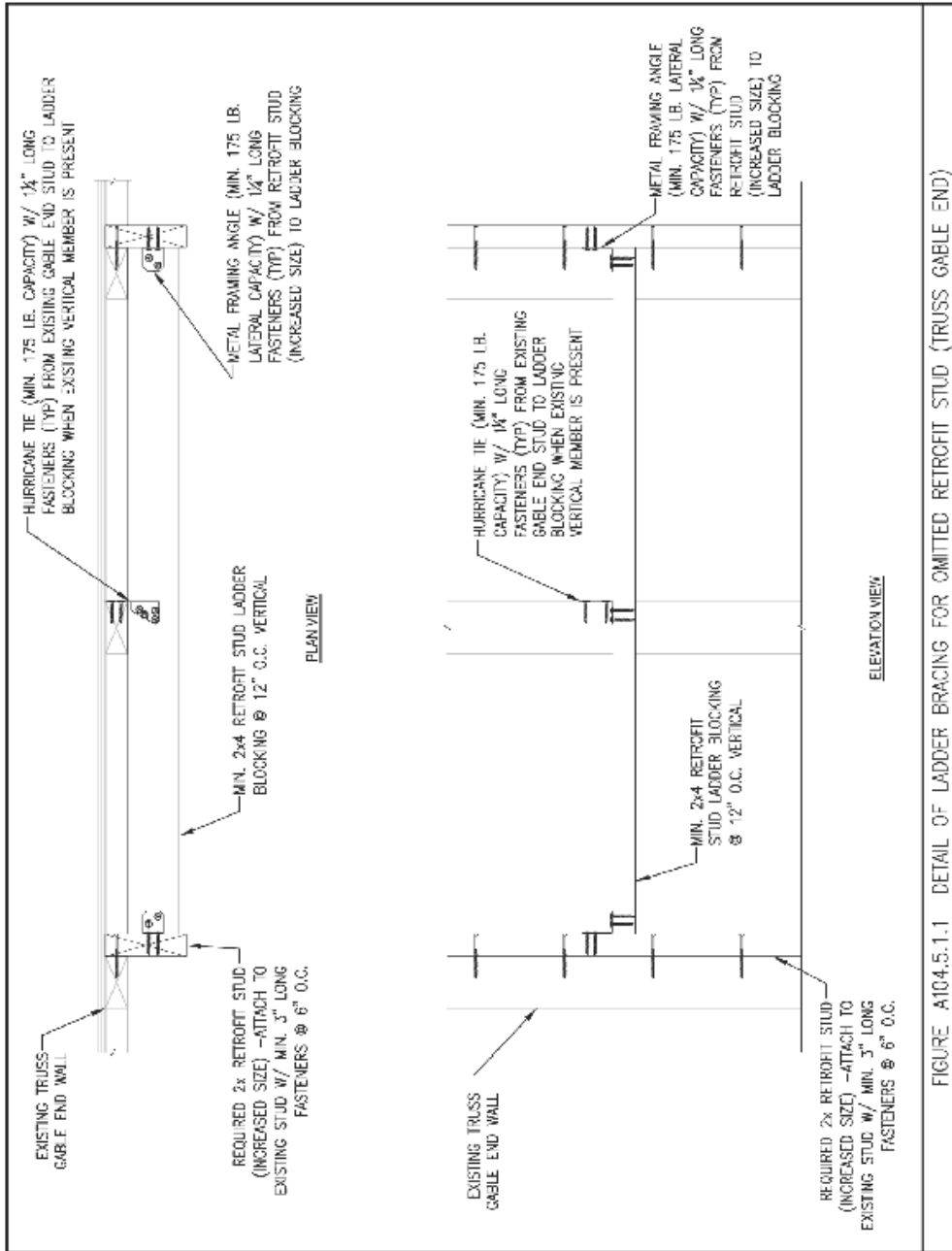

FIGURE A104.5.1.1 DETAIL OF LADDER BRACING FOR OMITTED RETROFIT STUD (TRUSS GABLE END)

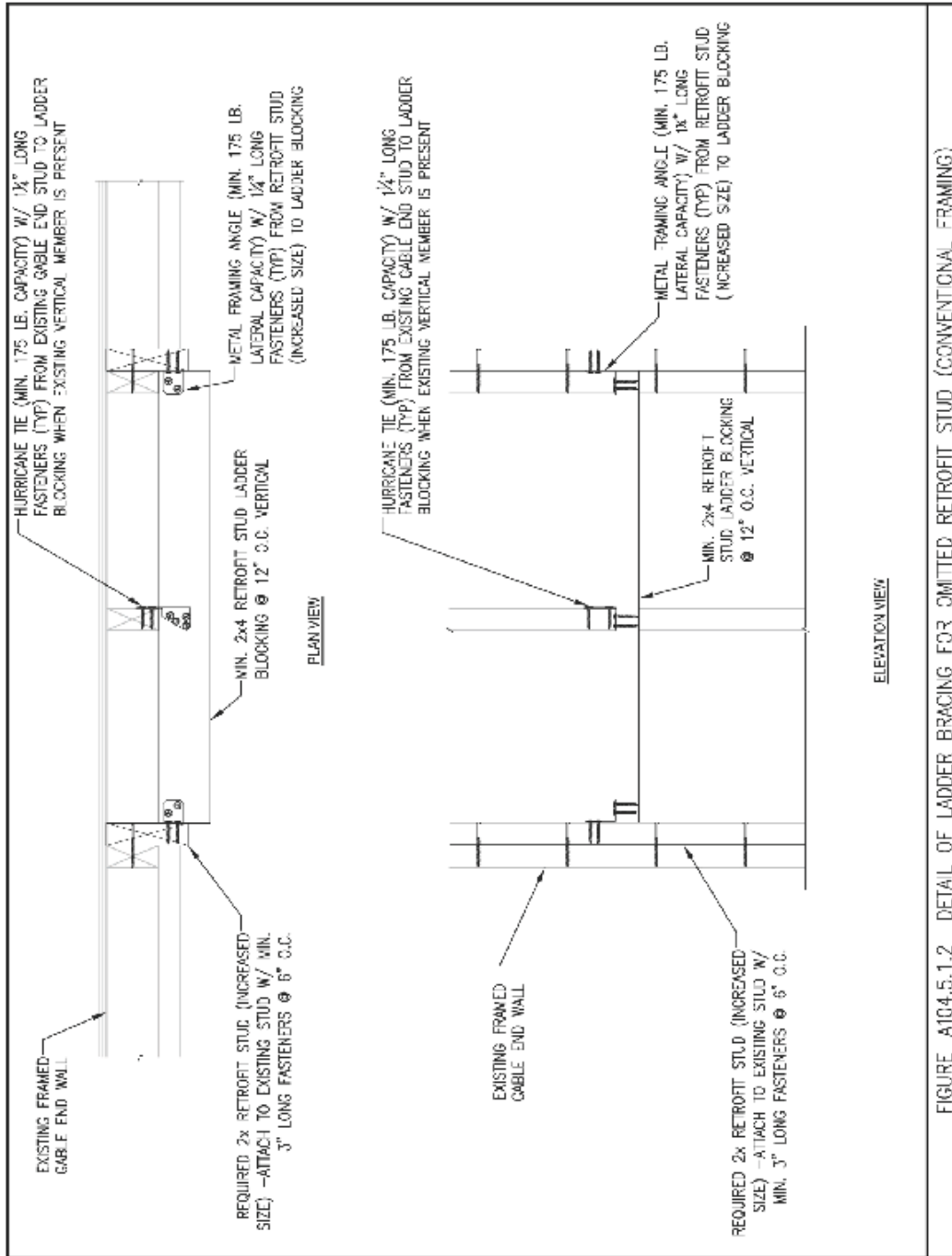
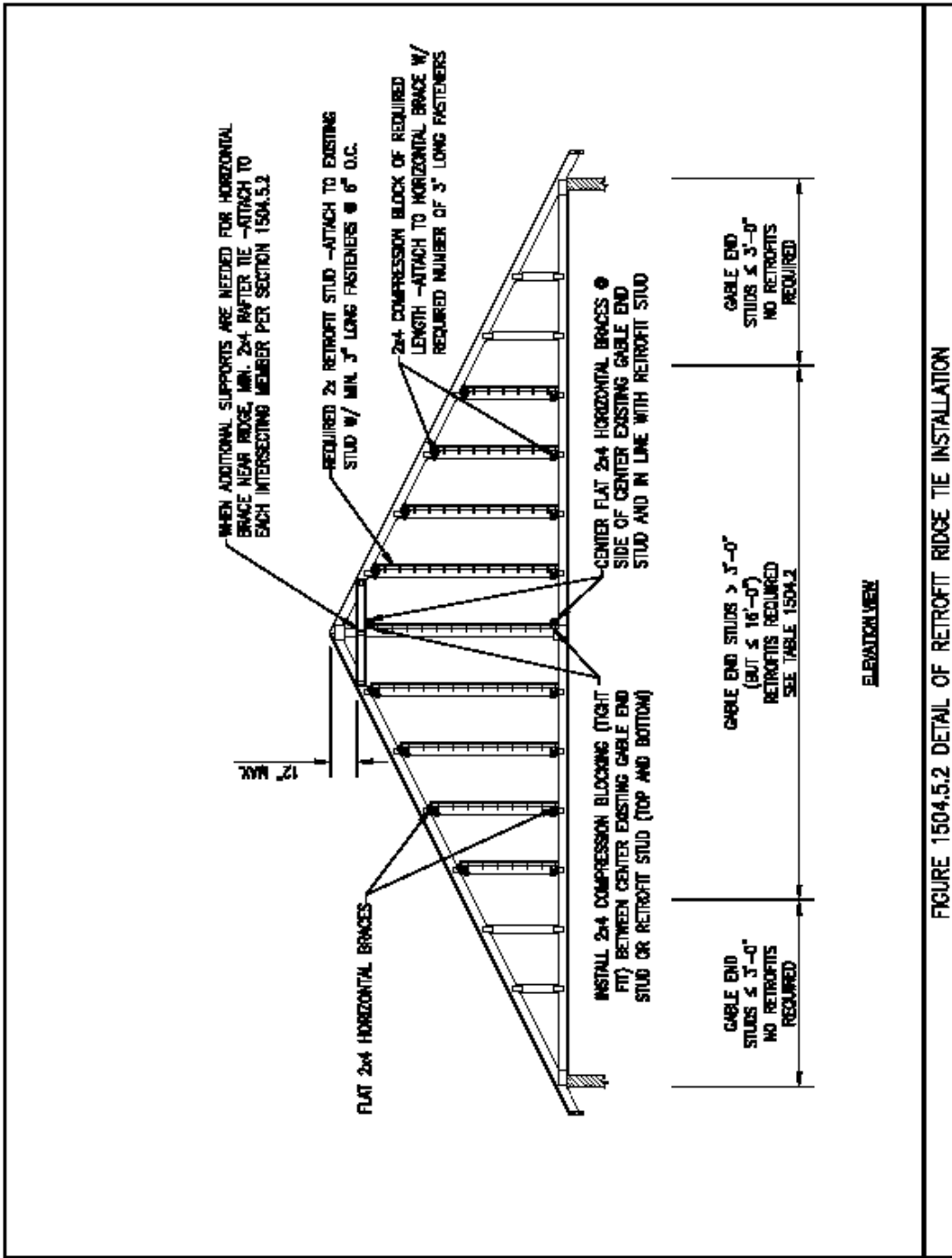

FIGURE A104.5.1.2 DETAIL OF LADDER BRACING FOR OMITTED RETROFIT STUD (CONVENTIONAL FRAMING)



**TABLE A104.2  
GABLE END RETROFIT ELEMENT SIZING AND FASTENING**

Exposure Category	Maximum 3-Sec Gust Basic Wind Speed (V) <sup>a</sup>	Maximum Height of Gable End Stud <sup>b</sup>			
		8'-0"	11'-3"	14'-9"	16'-0"
C	110	8'-0"	11'-3"	14'-9"	16'-0"
C	120	7'-6"	10'-6"	13'-6"	16'-0"
C	130	7'-0"	10'-0"	12'-3"	16'-0"
C	150	6'-6"	8'-9"	11'-0"	16'-0"
B	110	8'-0"	12'-3"	16'-0"	N/A <sup>c</sup>
B	130	8'-0"	11'-3"	14'-9"	16'-0"
B	140	7'-6"	10'-6"	13'-6"	16'-0"
B	150	7'-0"	10'-0"	12'-3"	16'-0"
<b>Reference Figures</b>					
	<b>Retrofit Elements</b>	<b>Figures A104.2.2 / A104.2.7</b>	<b>Figures A104.2.3 / A104.2.8</b>	<b>Figures A104.2.4 / A104.2.9</b>	<b>Figures A104.2.5 / A104.2.10</b>
1	Minimum Horizontal Brace	2x4	2x4	2x4	2 each 2x4
2	Minimum number of fasteners to connect Horizontal Brace to existing framing # 8 screws or 10d nails 3" long	3	3	3	3
3	Minimum Retrofit Stud	2x4	2x6	2x8	2 each 2x8
4	Minimum Flat Strap Anchor Length <sup>d</sup>	21"	30"	38"	2 straps 30"
5	Minimum number of fasteners to connect Flat Strap to Retrofit Stud 1 1/4" long fasteners 1 1/4" long	6	9	12	8 on each strap
6	Maximum on center spacing of fasteners to connect Retrofit Stud to Existing Stud # 8 screws or 10d nails 3" long	6"	6"	6"	6"
7	Minimum number of fasteners to connect Strap to Retrofit Stud 1 1/4" long fasteners 1 1/4" long	6	9	12	8 on each strap
8	Minimum length of Compression Block	11 1/4"	13 3/4"	16 1/4"	17 1/2"
9	Minimum number of fasteners to connect Compression Block to Horizontal Brace # 8 screws or 10d nails 3" long	6	8	10	12

For SI: 1 Inch = 25.4mm, 1 Foot = 304.8mm

- a. Interpolation between given wind speeds not permitted.
- b. Existing gable end studs less than or equal to 3'-0" in height shall not require retrofitting.
- c. N/A = Not Applicable. Exceeds 16'-0" maximum height.



**Table A104.6 Spacing of Right Angle Gusset Brackets**

Exposure Category	Maximum 3-Sec. Gust Wind Speed - V mph	Spacing of Right Angle Gusset Brackets <sup>a</sup>
C	110	38-inches
C	120	32-inches
C	130	28-inches
C	140	24-inches
C	150	20-inches
B	110	48-inches
B	120	40-inches
B	130	36-inches
B	140	30-inches
B	150	26-inches

a. See Section A104.2 for definition of right angle gusset bracket.