

**EFFICIENT HEATED WATER  
SUPPLY PIPING  
BCAIB #5009206  
CILB #0614470  
(1 hr.) Energy CEU**

**2020 Florida Building Code Energy Conservation Code  
2020 Florida Building Code Florida Plumbing  
BROWARD COUNTY BOARD OF RULES AND APPEALS  
Provider # 0001071  
License # PVD123**



**Instructors:**

**Timothy G. de Carion**

**Chief Energy Code Compliance Officer**

**Jose Cruz-Vellon**

**Chief Plumbing Code Compliance Officer**



# **What Are We Going To Cover Today?**

- **Reasons for Efficient Hot Water Piping**
- **Design Solutions**
- **New Technology**

## **Reasons for Efficient Hot Water Piping**

# **We Need to Save Water**



## **Reasons for Efficient Hot Water Piping**

Each day, hundreds of millions of US residents turn on their shower or faucet and wait on average 2 to 4 minutes to allow the water to get hot. A U.S. government study of water wasted per household reports approximately 7,500 to 12,000 gallons of water is lost per home with four taps each year. Larger homes waste even more water.



## Reasons for Efficient Hot Water Piping

Each day, hundreds of millions of US residents turn on their shower or faucet and wait on average 2 to 4 minutes to allow the water to get hot. A U.S. government study of water wasted per household reports approximately 7,500 to 12,000 gallons of water is lost per home with four taps each year. Larger homes waste even more water.

$$125 \text{ feet of } \frac{3}{4}'' \text{ pipe} = 3.14 \text{ gal}$$

$$10 \times \text{ per day} = 31 \text{ gal}$$

$$1 \text{ year} = 11,461 \text{ gal}$$

$$25 \text{ M homes} = 300 \text{ B gal/yr}$$

# **Reasons for Efficient Hot Water Piping**

## **Water is a Valuable Resource**



# Reasons for Efficient Hot Water Piping

## Some Local Jurisdictions In Florida Have Implemented Voluntary and Mandatory Measures To Reduce Water Consumption

### **307.2.1 Condensate drainage collection, use or disposal.**

Condensate from all cooling coils and evaporators of equipment served by an onsite cooling tower in a building or structure wherein the aggregate cooling capacity of the equipment exceeds 65,000 Btu/hr shall be collected and conveyed from the drain pan outlet and discharged to the cooling tower. Where an onsite cooling tower is not installed the condensate from all cooling coils and evaporators shall be conveyed from the drain pan outlet to an approved place of disposal. Such piping shall maintain a minimum horizontal slope in the direction of discharge of not less than one-eighth unit vertical in 12 units horizontal (1-percent slope). Condensate shall not discharge into a street, alley or other areas so as to cause a nuisance.

#### Exceptions:

1. Condensate from cooling coils and evaporators is not required to be collected and conveyed to an on-site cooling tower; provided 1.1 through 1.3 are met:

1.1 The equipment comprises 10% or less of the total capacity of the cooling tower system.

1.2 The equipment is located in an isolated or remote area.

1.3 The size of the equipment is 65,000 Btu/hr. or less.

2. In existing buildings condensate may be collected and conveyed to a cooling tower or discharged to an approved place of disposal.

### Water Shortage Warning for Broward County

*The South Florida Water Management District has issued a water shortage warning for the Lower East Coast, comprised of Monroe, Miami-Dade, Broward and Palm Beach counties. This warning is a call for area residents and agricultural water users to voluntarily reduce water consumption as a preemptive measure to avoid or forestall potential water shortage orders and mandatory water restrictions later in the dry season.*

*South Florida residents are asked to voluntarily limit the frequency of irrigation and reduce such wasteful water habits as taking long showers or allowing leaky fixtures to remain in disrepair.*

- Irrigation is where we can cut back the most: 50 percent of all potable (drinkable) water winds up on our lawns
- Our lawns don't need that much water during the dry season, particularly this year, as cooler dry season conditions are expected to result in less water lost to evaporation and transpiration through plants
- Residents should not need to water their lawns more than once a week if there is no rain – or not at all in weeks when it does rain
- Residents should begin to condition their landscapes for drier and cooler conditions by watering only when necessary and not on a regular "time clock" basis
- Visit the NatureScape Broward web site at [www.broward.org/naturescape](http://www.broward.org/naturescape) to learn more about conserving water in your yard
- We are asking residents to observe basic conservation practices within the home, such as taking shorter showers, washing full loads in dishwashers and clothes washers, and reducing excessive toilet flushing for disposing of items such as facial tissues and insects

*The South Florida Water Management District has recorded near record-low rainfall through the first 10 months of 2006.*

- At 1.05 inches of District-wide rainfall for the entire month, October 2006 was the third driest on record since 1932
- The first 10 months of 2006 have been the second driest on record, leaving many areas of the District in 1-in-25-year dry spells
- District-wide, we are about 10" below normal rainfall for 2006

*The South Florida Water Management District continues to monitor water levels and is working to avoid additional water shortage orders. However, more aggressive action might be needed.*

For more information on ways to save water visit  
[www.broward.org/watmatters](http://www.broward.org/watmatters)  
[www.broward.org/naturescape](http://www.broward.org/naturescape)  
[www.broward.org/iwrp/10ways.htm](http://www.broward.org/iwrp/10ways.htm)  
[www.broward.org/waterservices/waterwise.htm](http://www.broward.org/waterservices/waterwise.htm)  
[www.sfwmd.gov/conserve](http://www.sfwmd.gov/conserve)



# Reasons for Efficient Hot Water Piping

## Waiting for Hot Water Waists Water



# Reasons for Efficient Hot Water Piping

## We Need To Save Energy



- **Water Heating is one of the largest Residential Energy end-use items**
- **15 –30% of a Home's Total Energy Pie is Water Heating**

# Reasons for Efficient Hot Water Piping

Typical Household Energy Use in Florida

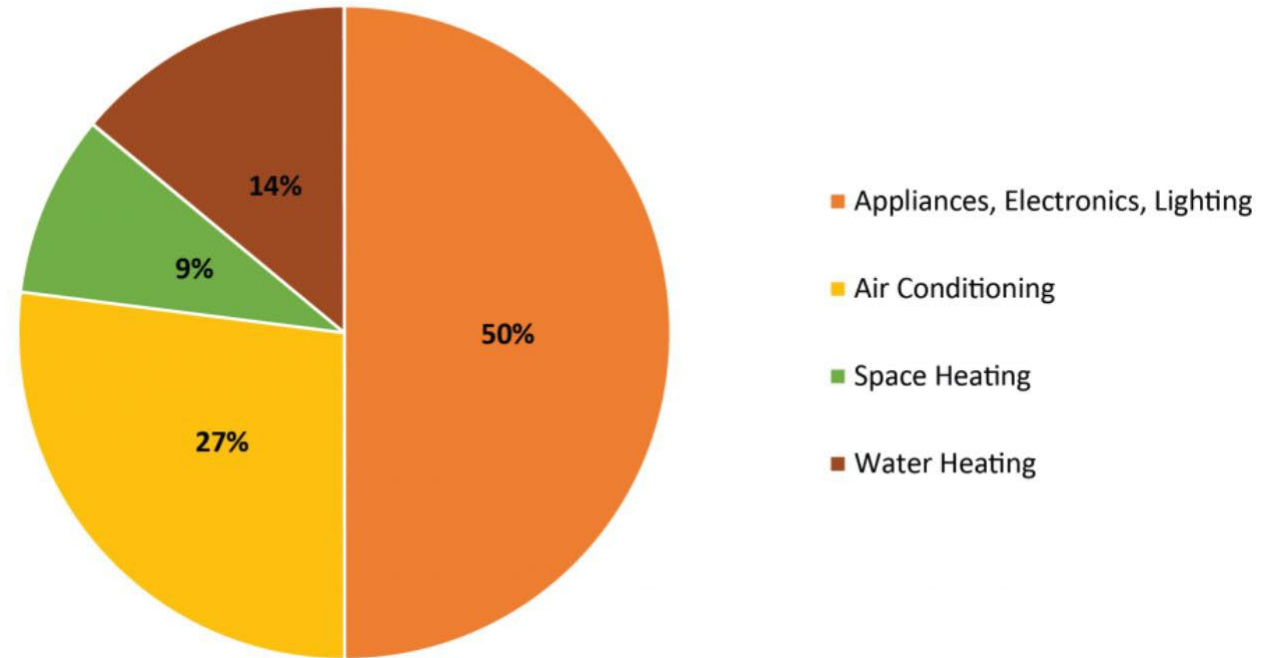

# Reasons for Efficient Hot Water Piping



U.S. DEPARTMENT OF  
**ENERGY**

**2018**

**The US Department of Energy estimates that 350 billion kilowatt-hours of energy is wasted every year because of hot water we don't use. For context, an average American home uses about 11,000 kilowatt-hours of electricity per year.**

# Design Solutions

- 1) Limit the Distance to the Source of Hot Water**
- 2) Insulate the Piping**
- 3) Utilize Controls**

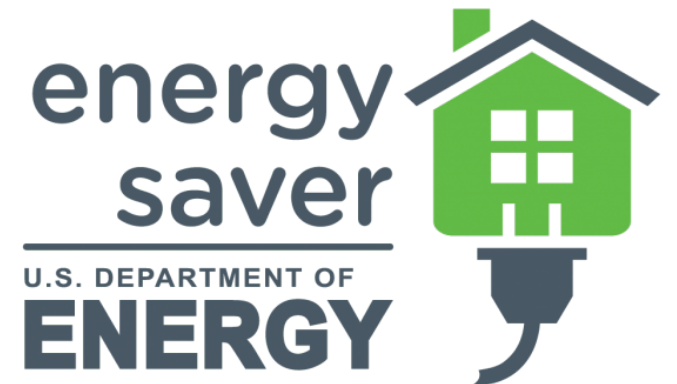

## #1 Limit the Distance to the Source of Hot Water

Gary Klein, a guru of efficient hot water delivery, has been pushing for change in hot water distribution systems for a long time. In recent years, he and his colleagues have developed a great tool for quantifying the efficiency of a hot water distribution system. It's called the:

### Hot Water System Rectangle.

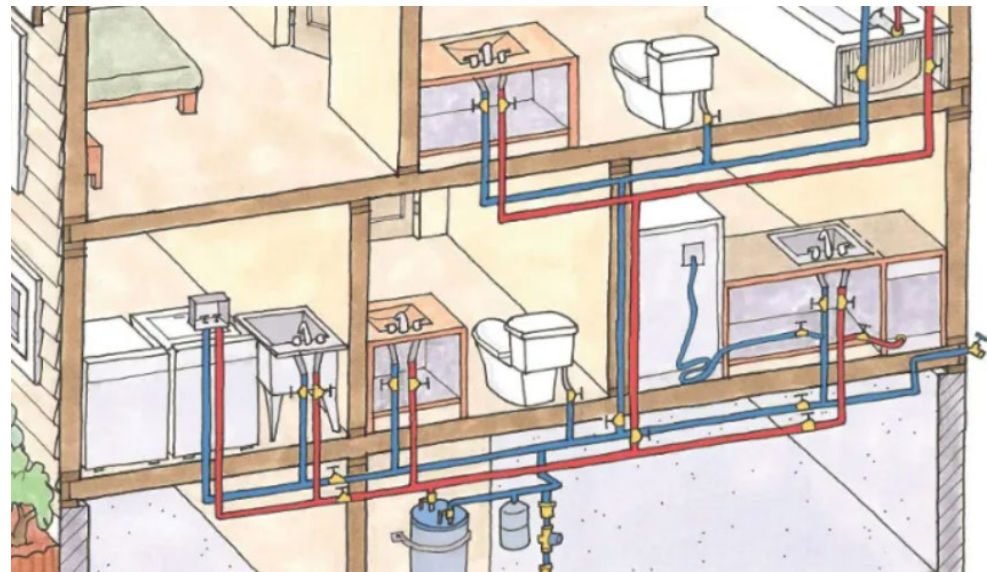

# Design Solutions

**#1 Limit the Distance to the Source of Hot Water**

**By Keeping All The Rooms That Use Hot Water in One Small Area**

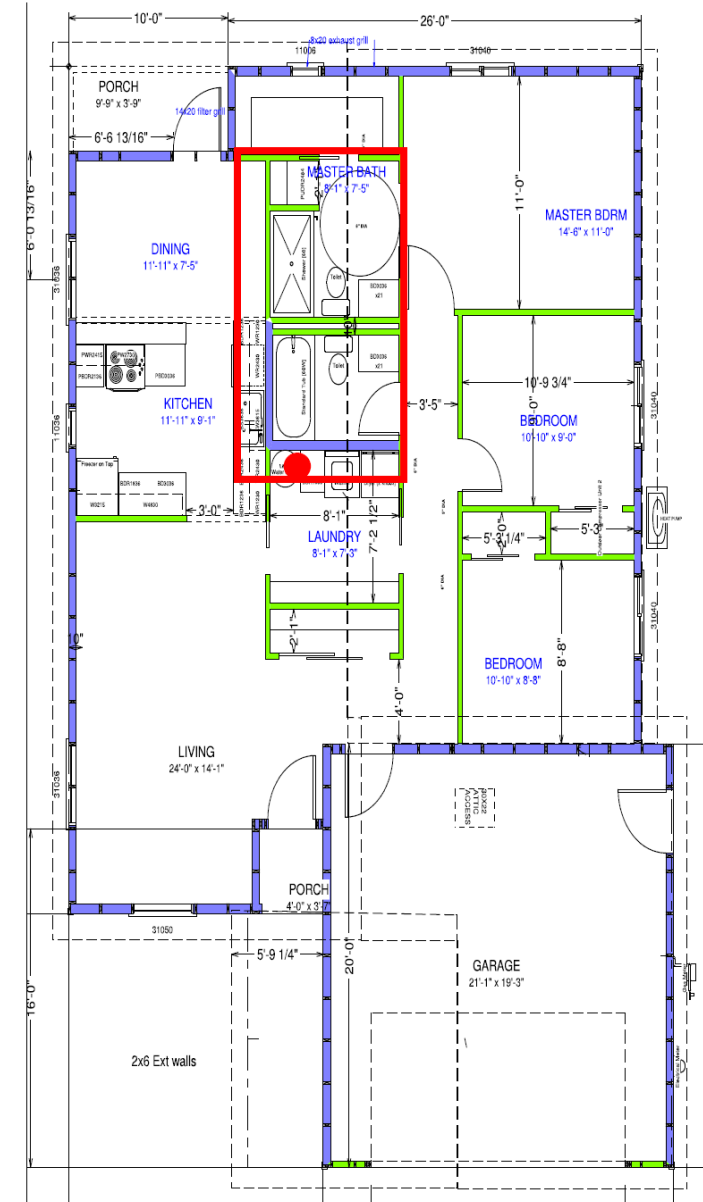

# #1 Limit the Distance to the Source of Hot Water

## Hot Water Rectangle

To find the hot water rectangle, you draw the smallest rectangle possible that includes the water heater and all the hot water fixtures in a house.

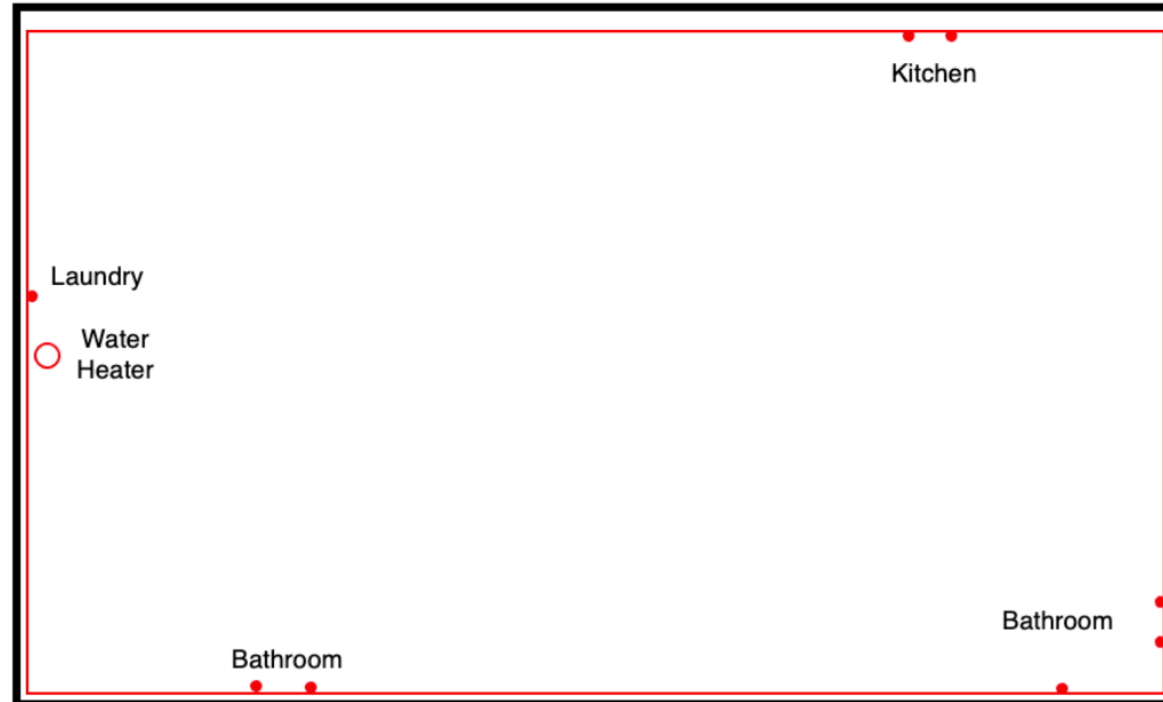

Hot Water Rectangle: 93%



# Design Solutions

## The Hot Water Rectangle



Hot Water Rectangle: 26%

# Design Solutions

## The Hot Water Rectangle

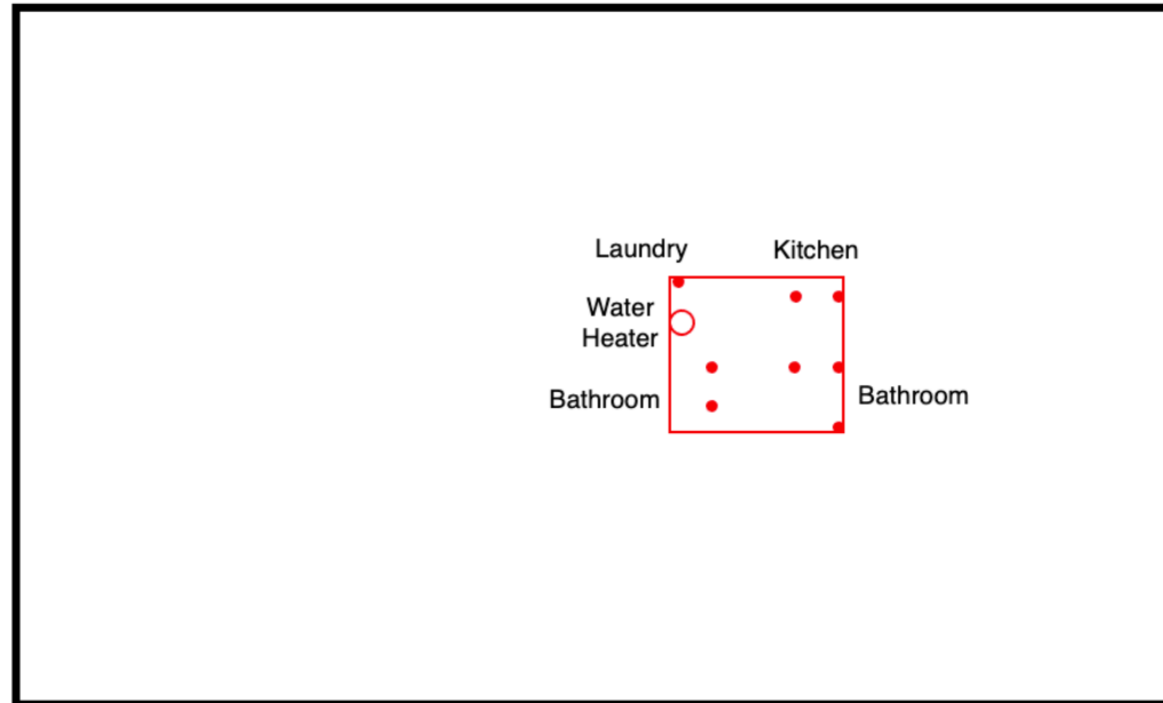

Hot Water Rectangle: 3%

# Design Solutions

## **#1 Limit the Distance to the Source of Hot Water**

**Depending on the size of the Home, a Residence on Average has about 125 feet of  $\frac{3}{4}$  inch pipe holding about 3.14 gallons of Coldwater.**

**The Design Professional can utilize tools to Calculate Water Volume**

# Design Solutions

## Pipe Length and Water Volume Calculator

Type of system:

Fixture  Fixture 1

<b>Trunk:</b>	
piping: <input type="text" value="Copper L"/>	diameter: <input type="text" value="3/4"/>
length (feet) <input type="text" value="125"/>	ounces/ft: 3.22      volume (oz): 402.5
<b>Branch:</b>	
piping: <input type="text" value="Copper L"/>	diameter: <input type="text" value="1/2"/>
length (feet) <input type="text" value="0"/>	ounces/ft: 1.55      volume (oz): 0
<b>Twig:</b>	
piping: <input type="text" value="Copper L"/>	diameter: <input type="text" value="1/2"/>
length (feet) <input type="text" value=""/>	ounces/ft: 1.55      volume (oz): 0
<b>total</b>	
length (feet)      125	volume (oz): 402.5

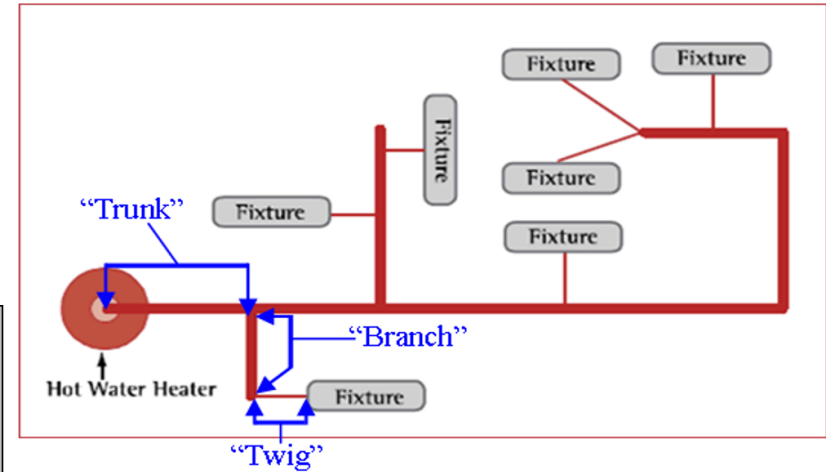

**Trunk:** The large diameter piping that runs from the water heater toward multiple points of use.

**Branch:** The pipe that runs off the main trunk toward a cluster of fixtures (such as a bathroom or a kitchen).

**Twig:** The small diameter piping that serves an individual fixture.

# Design Solutions

## WATER SUPPLY PIPING TERMINOLOGY

- 1) Twig Line- Small Diameter Pipe that Serves the Fixture
- 2) Branch Line- Pipe that Runs Off the Main
- 3) Trunk- Large Diameter Pipe that Runs from the Water Heater to the Point of use.

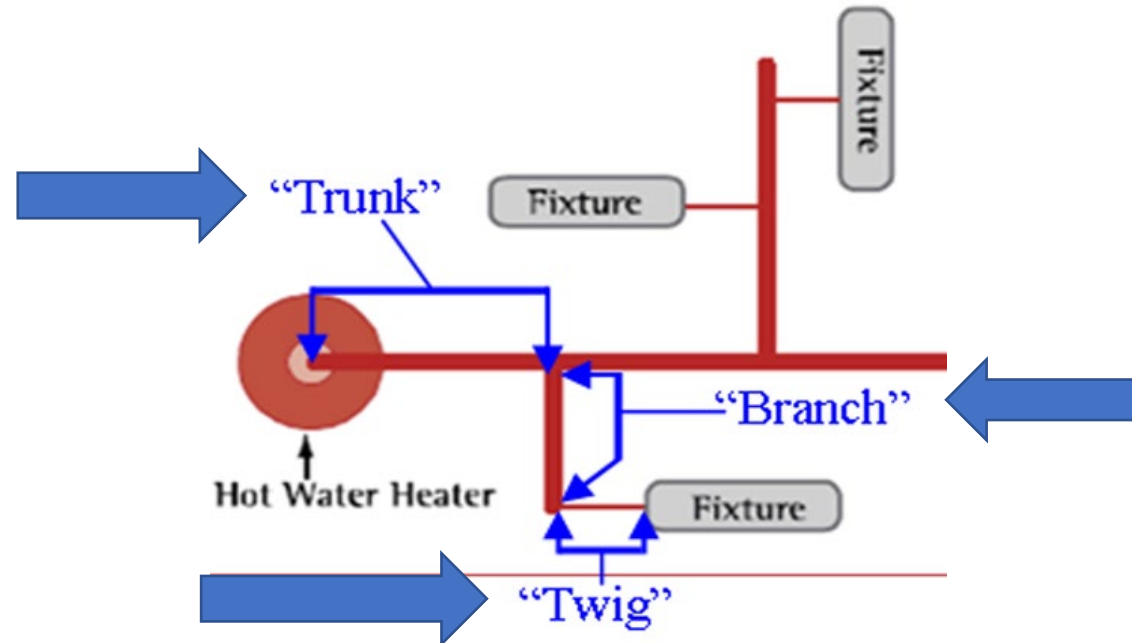

# Design Solutions

**The FBC Residential Plumbing Code Limits the Maximum Length of Hot Water Piping Allowed in a Residence from the Source of Hot Water to the Plumbing Fixture to 100 Feet**



# Design Solutions

## 2020 FBC Residential Code

**P2905.3 Hot water supply to fixtures.** The developed length of hot water piping, from the source of hot water to the fixtures that require hot water, shall not exceed 100 feet. Water heaters and recirculating system piping shall be considered to be sources of hot water.

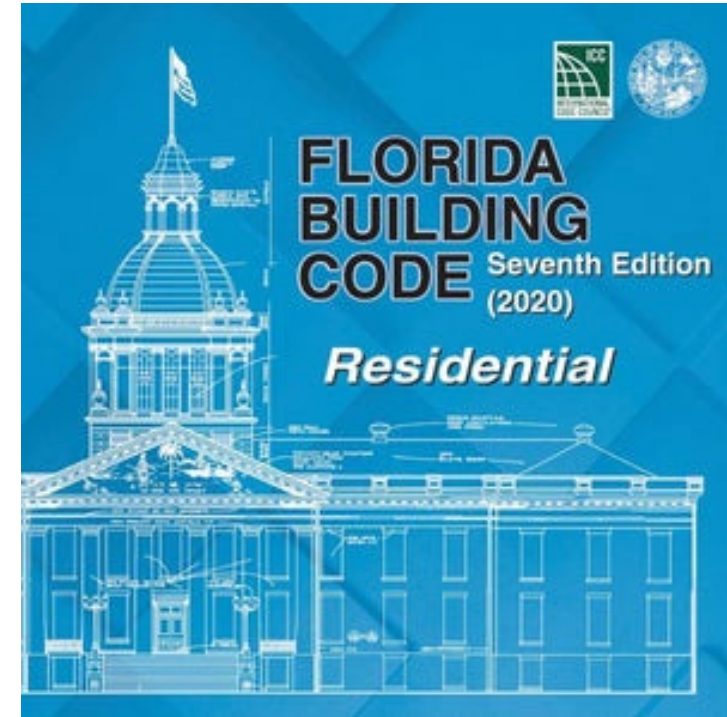

# Design Solutions

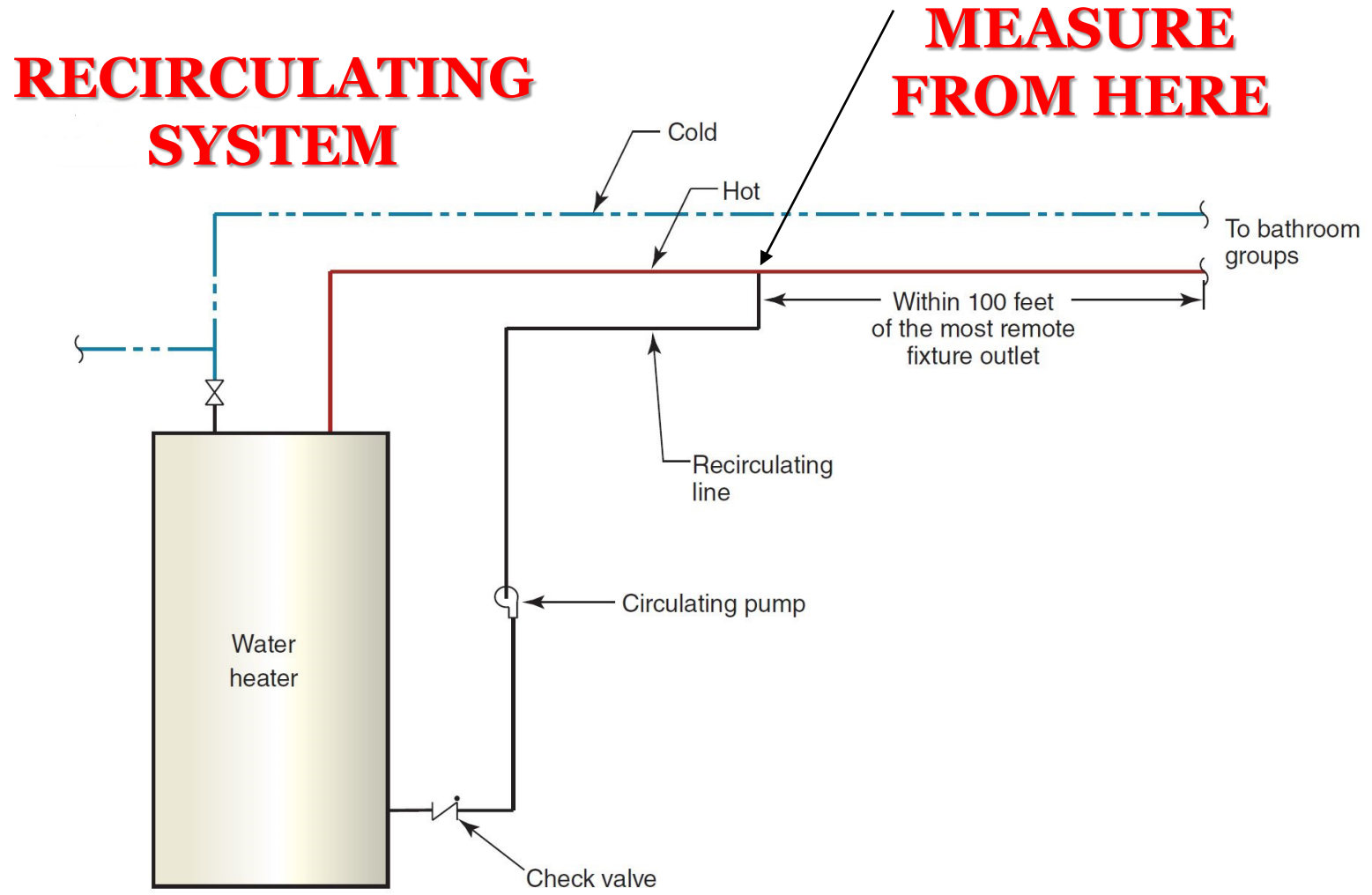

Hot water piping is limited to 100 feet from the source.



# Design Solutions

**The FBC Plumbing Code Limits the Maximum Length of Hot Water Piping Allowed in a Commercial Building from the Source of Hot Water to the Plumbing fixture to 50 Feet.**



# Design Solutions

## 2020 Plumbing Code

**607.2 Hot or tempered water supply to fixtures.** The developed length of hot or tempered water piping, from the source of hot water to the fixtures that require hot or tempered water, shall not exceed 50 feet.

Recirculating system piping and heat-traced piping shall be considered to be sources of hot or tempered water.

**BUT!!**

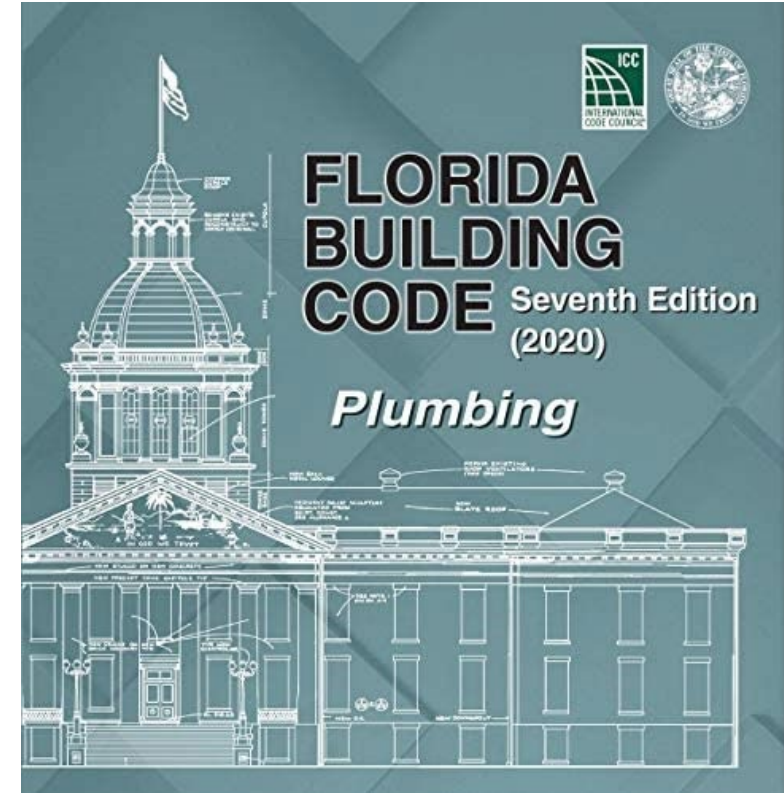

# Design Solutions

**The FBC Energy Conservation Code Limits the Maximum Length of Hot Water Piping Allowed in a Commercial Building from the Source of Hot Water to the Plumbing fixture to a Chart.**

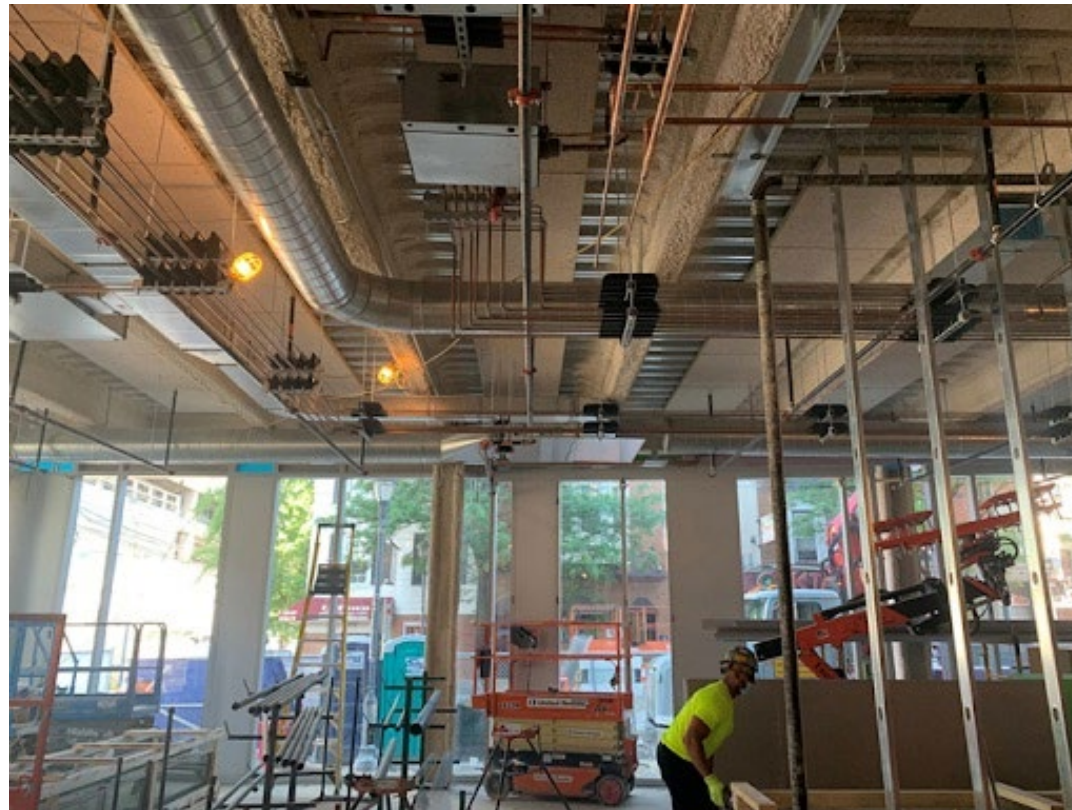

# Design Solutions

## 2020 Energy Code

**C404.5 Efficient heated water supply piping.** Heated water supply piping shall be in accordance with Section C404.5.1 or C404.5.2.

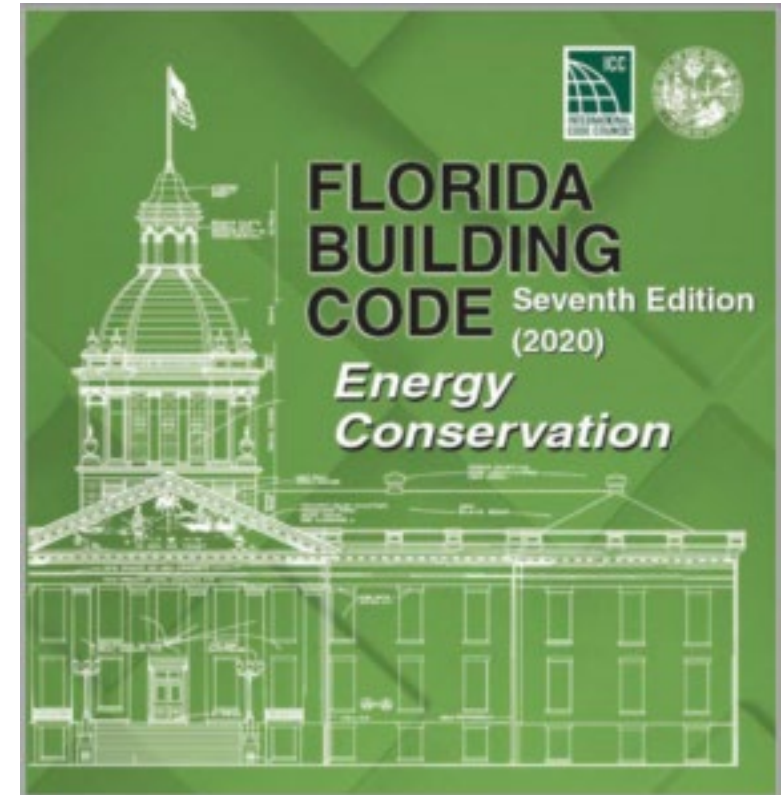

**2020 Plumbing Code ?  
P607.2**

**2020 Energy Code ?  
C404.5.1**

**(50 Feet)**

**Which Code To Use?**

**(Table C404.5.1)**

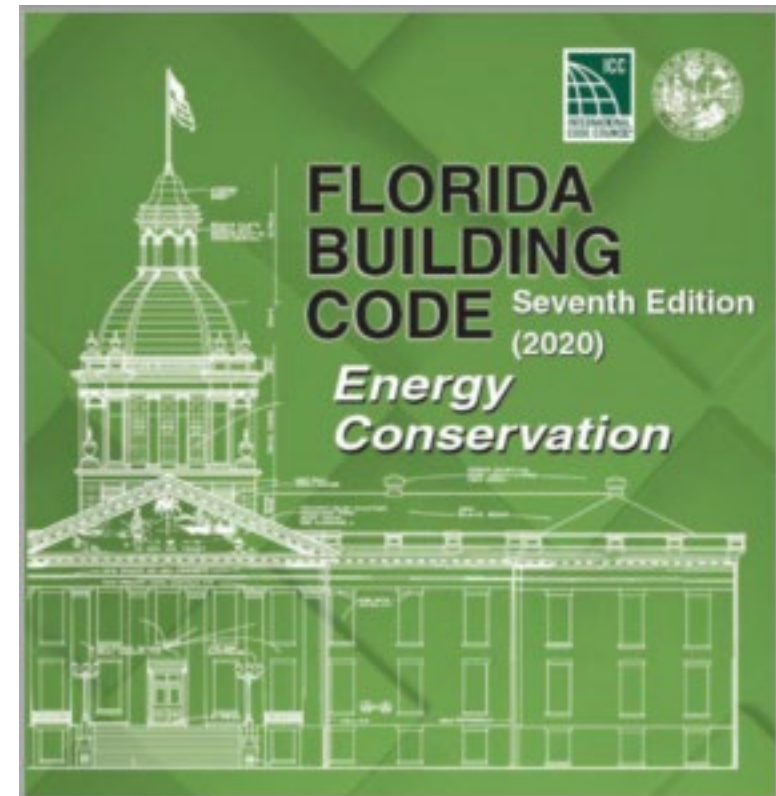
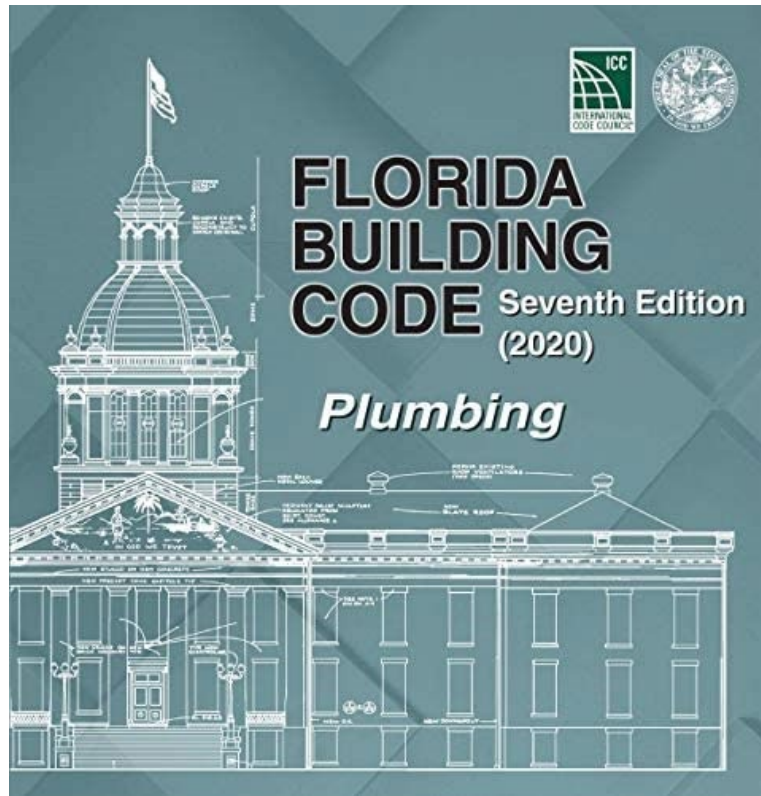



## **Chapter 1 Administrative Code**

**102.1 General.** Where there is a conflict between a general requirement and a specific requirement, the specific requirement shall be applicable. Where, in any specific case, different sections of this Code specify different materials, methods of construction or other requirements, the most restrictive shall govern.

## 2020 Energy Conservation Code

**C404.5 Efficient heated water supply piping.** Heated water supply piping shall be in accordance with Section C404.5.1 or C404.5.2.

### Two Methods to Calculate Code Limitations

- 1) **C404.5.1** Maximum allowable pipe length method
- 2) **C404.5.2** Maximum allowable pipe volume method

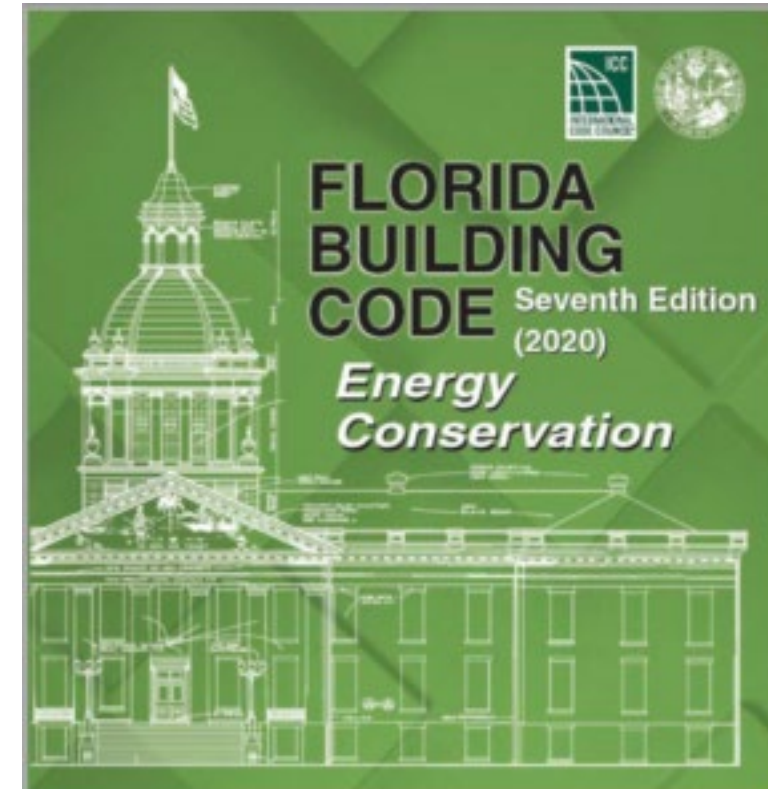

# Pipe Length Method Uses Largest Pipe Size



TABLE C404.5.1  
PIPING VOLUME AND MAXIMUM PIPING LENGTHS

NOMINAL PIPE SIZE (inches)	VOLUME (liquid ounces per foot length)	MAXIMUM PIPING LENGTH (feet)	
		Public lavatory faucets	Other fixtures and appliances
$\frac{1}{4}$	0.33	6	50
$\frac{5}{16}$	0.5	4	50
$\frac{3}{8}$	0.75	3	50
$\frac{1}{2}$	1.5	2	43
$\frac{5}{8}$	2	1	32
$\frac{3}{4}$	3	0.5	21
$\frac{7}{8}$	4	0.5	16
1	5	0.5	13
$1\frac{1}{4}$	8	0.5	8
$1\frac{1}{2}$	11	0.5	6
2 or larger	18	0.5	4

For SI: 1 inch = 25.4 mm, 1 foot = 304.8 mm, 1 liquid ounce = 0.030 L, 1 gallon = 128 ounces.



# Design Solutions

## And The Type of Fixture



TABLE C404.5.1  
PIPING VOLUME AND MAXIMUM PIPING LENGTHS

NOMINAL PIPE SIZE (inches)	VOLUME (liquid ounces per foot length)	MAXIMUM PIPING LENGTH (feet)	
		Public lavatory faucets	Other fixtures and appliances
$\frac{1}{4}$	0.33	6	50
$\frac{5}{16}$	0.5	4	50
$\frac{3}{8}$	0.75	3	50
$\frac{1}{2}$	1.5	2	43
$\frac{5}{8}$	2	1	32
$\frac{3}{4}$	3	0.5	21
$\frac{7}{8}$	4	0.5	16
1	5	0.5	13
$1\frac{1}{4}$	8	0.5	8
$1\frac{1}{2}$	11	0.5	6
2 or larger	18	0.5	4

For SI: 1 inch = 25.4 mm, 1 foot = 304.8 mm, 1 liquid ounce = 0.030 L, 1 gallon = 128 ounces.

# Design Solutions

**Code for Public Lavatory Faucets are Very Restrictive**

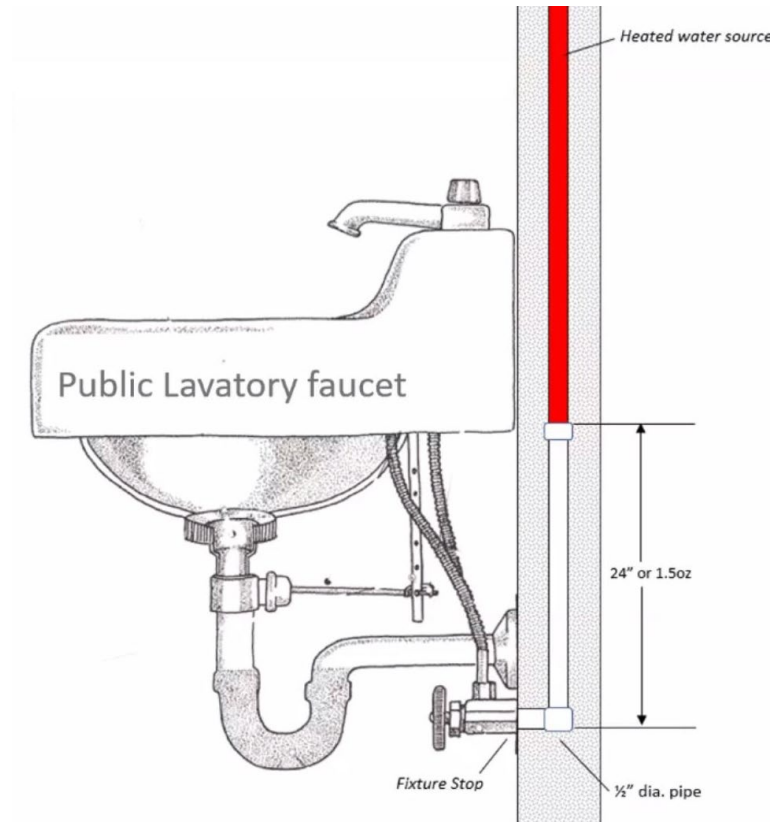

# Design Solutions

## Fixture Type

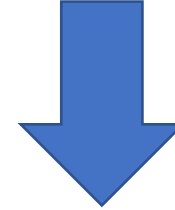

TABLE C404.5.1  
PIPING VOLUME AND MAXIMUM PIPING LENGTHS

NOMINAL PIPE SIZE (inches)	VOLUME (liquid ounces per foot length)	MAXIMUM PIPING LENGTH (feet)	
		Public lavatory faucets	Other fixtures and appliances
$\frac{1}{4}$	0.33	6	50
$\frac{5}{16}$	0.5	4	50
$\frac{3}{8}$	0.75	3	50
$\frac{1}{2}$	1.5	2	43
$\frac{5}{8}$	2	1	32
$\frac{3}{4}$	3	0.5	21
$\frac{7}{8}$	4	0.5	16
1	5	0.5	13
$1\frac{1}{4}$	8	0.5	8
$1\frac{1}{2}$	11	0.5	6
2 or larger	18	0.5	4

For SI: 1 inch = 25.4 mm, 1 foot = 304.8 mm, 1 liquid ounce = 0.030 L, 1 gallon = 128 ounces.

# Design Solutions

## 2020 Change in the Plumbing Code

### **HOT WATER IS NOT REQUIRED FOR PUBLIC HAND-WASHING FACILITIES**

**419.5 Water for public hand-washing facilities.** *Cold or tempered water* shall be delivered from lavatories and group wash fixtures located in public toilet facilities provided for customers, patrons and visitors. *Tempered water* shall be delivered through an *approved* water-temperature limiting device that conforms to ASSE 1070 or CSA B125.3.



# Design Solutions

## Water Volume Method Uses Ounces of Water



TABLE C404.5.1  
PIPING VOLUME AND MAXIMUM PIPING LENGTHS

NOMINAL PIPE SIZE (inches)	VOLUME (liquid ounces per foot length)	MAXIMUM PIPING LENGTH (feet)	
		Public lavatory faucets	Other fixtures and appliances
$\frac{1}{4}$	0.33	6	50
$\frac{5}{16}$	0.5	4	50
$\frac{3}{8}$	0.75	3	50
$\frac{1}{2}$	1.5	2	43
$\frac{5}{8}$	2	1	32
$\frac{3}{4}$	3	0.5	21
$\frac{7}{8}$	4	0.5	16
1	5	0.5	13
$1\frac{1}{4}$	8	0.5	8
$1\frac{1}{2}$	11	0.5	6
2 or larger	18	0.5	4

For SI: 1 inch = 25.4 mm, 1 foot = 304.8 mm, 1 liquid ounce = 0.030 L, 1 gallon = 128 ounces.

# Design Solutions

**Water Volume Method Uses Ounces of Water per Ft.**

**Not To Exceed 1/2 Gal. or 64 oz.**



TABLE C404.5.1  
PIPING VOLUME AND MAXIMUM PIPING LENGTHS

NOMINAL PIPE SIZE (inches)	VOLUME (liquid ounces per foot length)	MAXIMUM PIPING LENGTH (feet)	
		Public lavatory faucets	Other fixtures and appliances
1/4	0.33	6	50
5/16	0.5	4	50
3/8	0.75	3	50
1/2	1.5	2	43
5/8	2	1	32
3/4	3	0.5	21
7/8	4	0.5	16
1	5	0.5	13
1 1/4	8	0.5	8
1 1/2	11	0.5	6
2 or larger	18	0.5	4

For SI: 1 inch = 25.4 mm, 1 foot = 304.8 mm, 1 liquid ounce = 0.030 L, 1 gallon = 128 ounces.

# Design Solutions

## #2 Insulate the Piping



# Design Solutions

## Insulating Piping Reduces Standby Loss

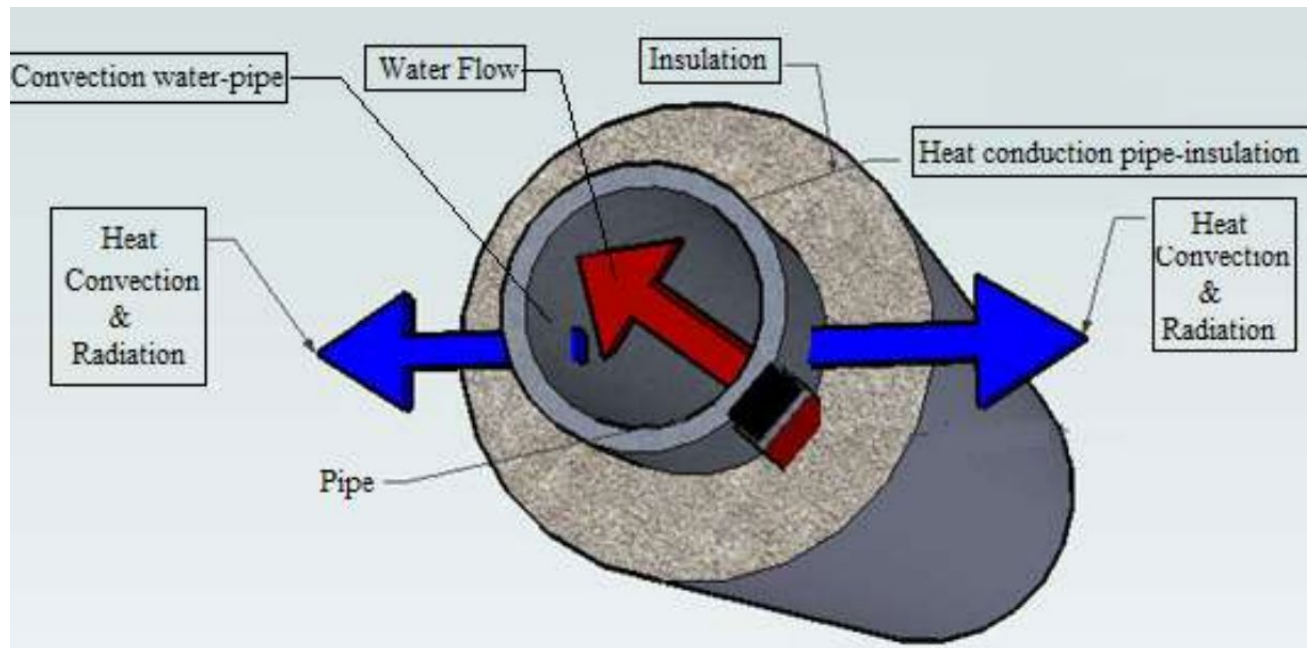



## Energy Conservation Code (Residential)

### **R403.5.3 Hot water pipe insulation**

Insulation for hot water pipe with a minimum thermal resistance (*R*-value) of R-3 shall be applied to the following:

7. Supply and return piping in recirculation systems other than demand recirculation systems.



## Energy Conservation Code (Commercial)

### C404 (Mandatory)

**C404.4 Insulation of Piping** The following piping shall be insulated to levels shown in Table C403.2.10:

- a. **Recirculating system piping**, including the supply and return piping of a circulating tank type water heater.
- b. **The first 8 feet of outlet piping** for a constant-temperature nonrecirculating storage system.
- c. **The first 8 feet of branch piping connecting to recirculated**, heat-traced, or impedance heated piping.
- d. **The inlet piping between the storage tank and a *heat trap*** in a nonrecirculating storage system.
- e. **Piping that is externally heated** (such as heat trace or impedance heating).

# Design Solutions

**Pipe Size and Temperature Determines the Thickness of the Pipe Insulation**



# Design Solutions

## TABLE 403.2.10 Determines Insulation Thickness

TABLE C403.2.10  
MINIMUM PIPE INSULATION THICKNESS (in inches)<sup>a, c</sup>

FLUID OPERATING TEMPERATURE RANGE AND USAGE (°F)	INSULATION CONDUCTIVITY		NOMINAL PIPE OR TUBE SIZE (inches)				
	Conductivity Btu · in./(h · ft <sup>2</sup> · °F) <sup>b</sup>	Mean Rating Temperature, °F	< 1	1 to < 1½	1½ to < 4	4 to < 8	≥ 8
> 350	0.32 – 0.34	250	4.5	5.0	5.0	5.0	5.0
251 – 350	0.29 – 0.32	200	3.0	4.0	4.5	4.5	4.5
201 – 250	0.27 – 0.30	150	2.5	2.5	2.5	3.0	3.0
141 – 200	0.25 – 0.29	125	1.5	1.5	2.0	2.0	2.0
105 – 140	0.21 – 0.28	100	1.0	1.0	1.5	1.5	1.5
40 – 60	0.21 – 0.27	75	0.5	0.5	1.0	1.0	1.0
< 40	0.20 – 0.26	50	0.5	1.0	1.0	1.0	1.5

For SI: 1 inch = 25.4 mm, °C = [(°F) - 32]/1.8.

- For piping smaller than 1½ inches and located in partitions within conditioned spaces, reduction of these thicknesses by 1 inch shall be permitted (before thickness adjustment required in footnote b) but not to a thickness less than 1 inch.
- For insulation outside the stated conductivity range, the minimum thickness (T) shall be determined as follows:

$$T = r\{(1 + t/r)K/k - 1\}$$

where:

*T* = minimum insulation thickness,

*r* = actual outside radius of pipe,

*t* = insulation thickness listed in the table for applicable fluid temperature and pipe size,

*K* = conductivity of alternate material at mean rating temperature indicated for the applicable fluid temperature Btu · in/(h · ft<sup>2</sup> · °F) and

*k* = the upper value of the conductivity range listed in the table for the applicable fluid temperature.

- For direct-buried heating and hot water system piping, reduction of these thicknesses by 1½ inches (38 mm) shall be permitted (before thickness adjustment required in footnote b) but not to thicknesses less than 1 inch (25 mm).

# Design Solutions

## #3 Utilize Controls



# Design Solutions

## Two Types of Hot Water Systems

**CIRCULATING HOT WATER SYSTEM.** A specifically designed water distribution system where one or more pumps are operated in the service hot water piping to circulate heated water from the water-heating equipment to the fixture supply and back to the water-heating equipment. (Has a dedicated return line)

**DEMAND RECIRCULATION WATER SYSTEM.** A water distribution system where pumps prime the service hot water piping with heated water upon demand for hot water. (Uses the supply)

# Design Solutions

## CIRCULATING HOT WATER SYSTEM Pump at Heater

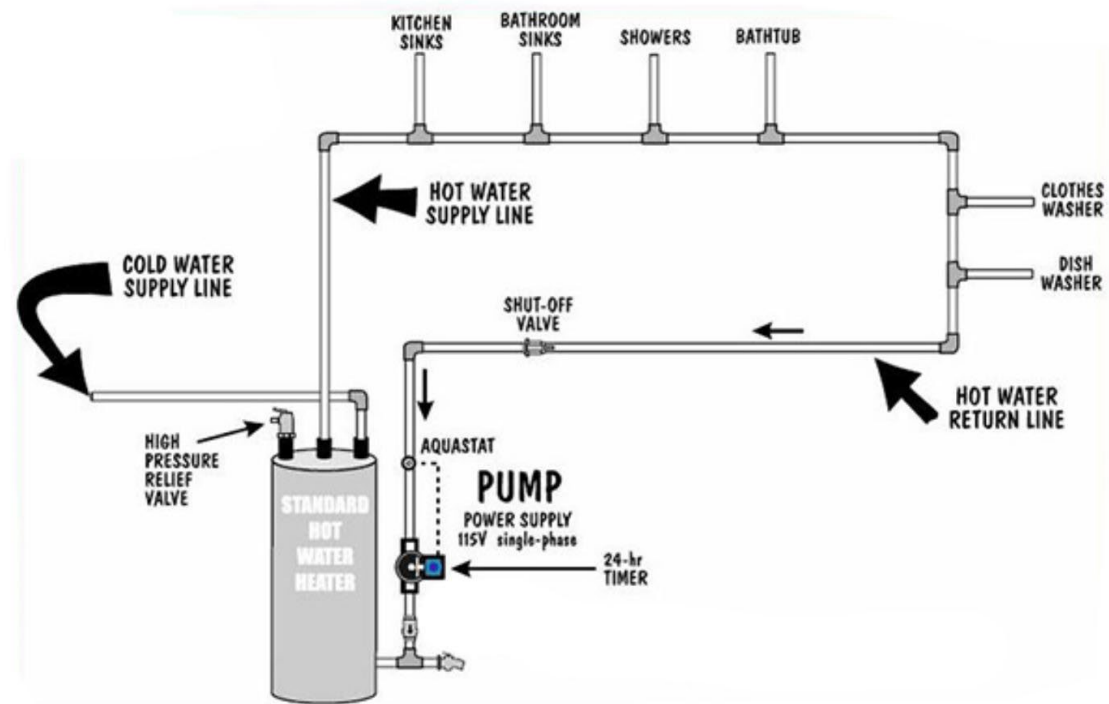

# Design Solutions

## DEMAND RECIRCULATING WATER SYSTEM Pump at Furthest Fixture

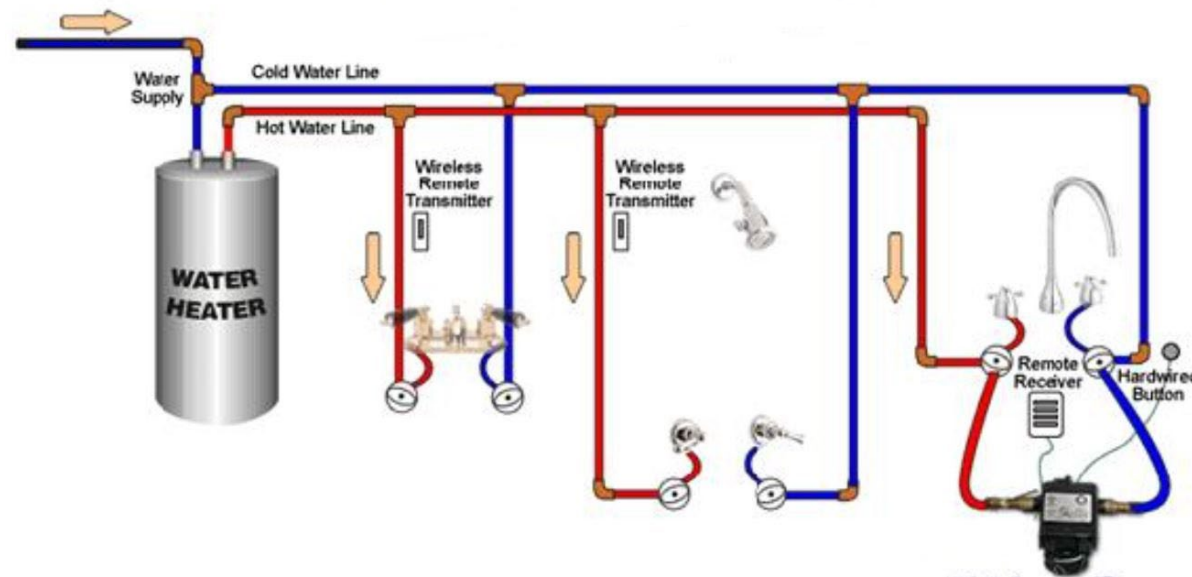

**No Dedicated Return Pipe  
Uses Existing Cold-Water Supply Pipe**



# Design Solutions

## DEMAND RECIRCULATION WATER SYSTEM Tankless Pump at Heater

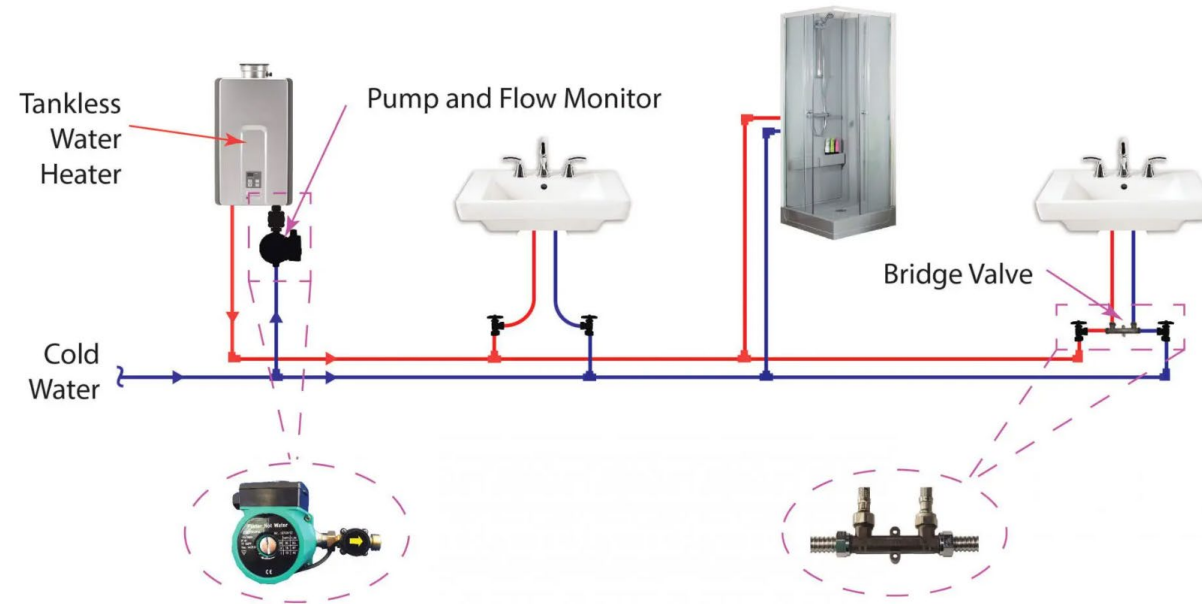

**No Dedicated Return Pipe  
Uses Existing Cold-Water Supply Pipe**

# 2020 Plumbing Code

**607.2.1 Circulation systems and heat trace systems for maintaining heated water temperature in distribution systems.** For Group R2, R3 and R4 occupancies that are three stories or less in height above grade plane, the installation of heated water circulation and temperature maintenance systems shall be in accordance with Section R403.5.1 of the *Florida Building Code, Energy Conservation*. For other than Group R2, R3 and R4 occupancies that are three stories or less in height above grade plane, the installation of heated water circulation and heat trace systems shall be in accordance with Section C404.6 of the *Florida Building Code, Energy Conservation*

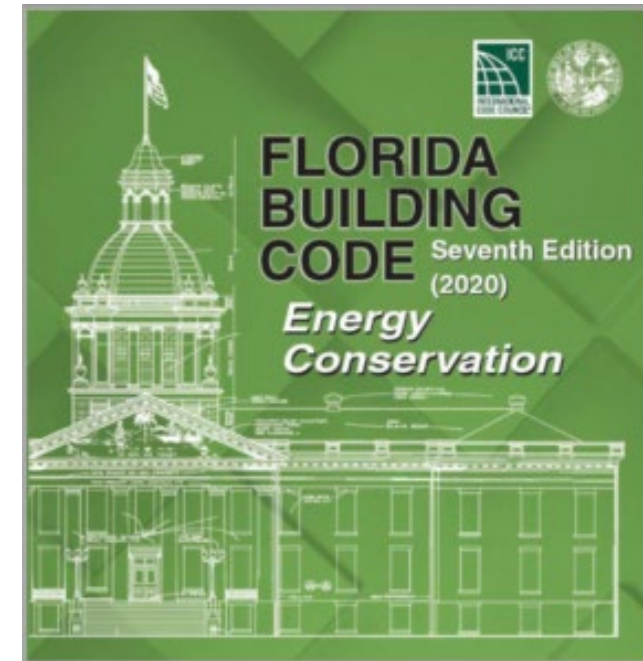
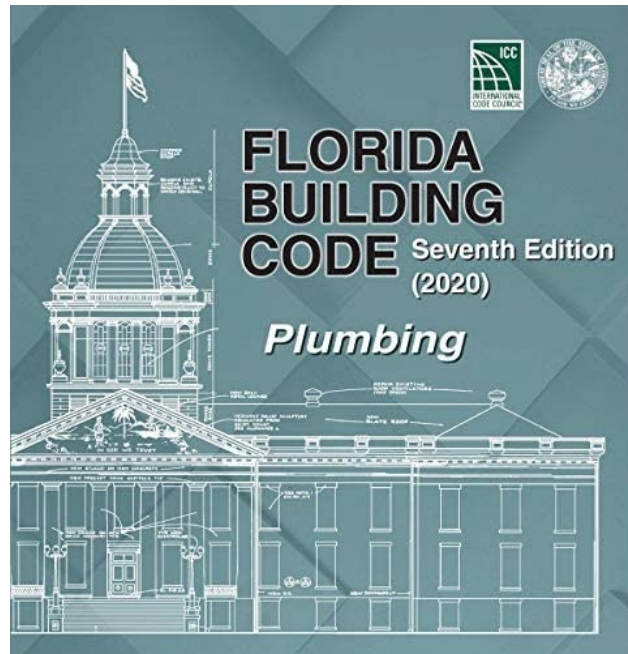

# 2020 Energy Code

**R403.5.1 Heated water circulation and temperature maintenance systems (Mandatory).** If heated water circulation systems are installed, they shall be in accordance with Section R403.5.1.1

**C404.6 Heated-water circulating and temperature maintenance systems.** Heated-water circulation systems shall be in accordance with Section C404.6.1.

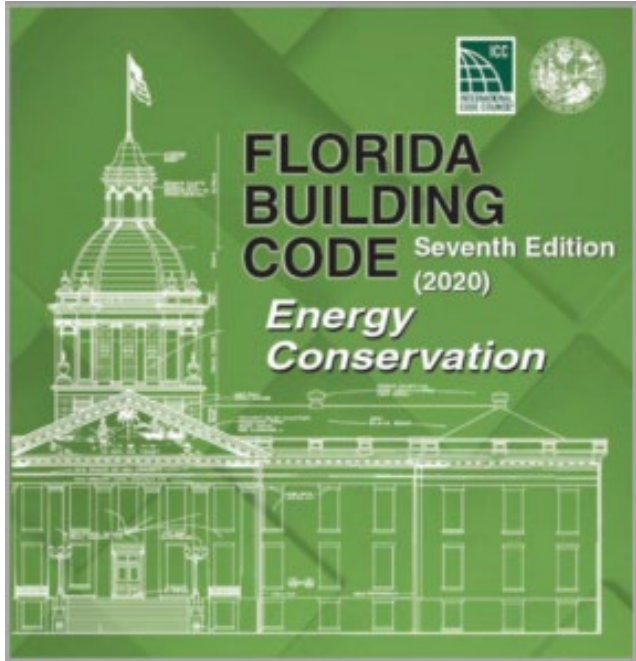
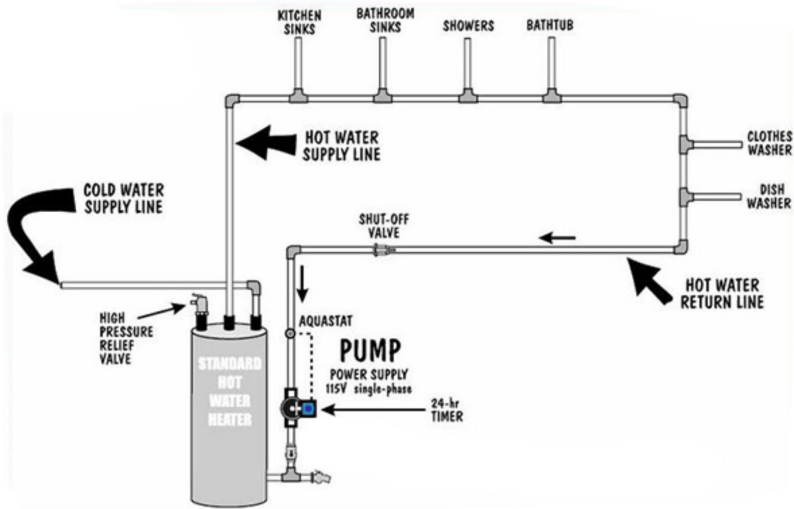

# 2020 Energy Code Residential

## **R403.5.1.1 Circulation systems.**

Heated water circulation systems shall be provided with a circulation pump. The system return pipe shall be a dedicated return pipe or a cold-water supply pipe. Gravity and thermosyphon circulation systems shall be prohibited. Controls for circulating hot water system pumps shall start the pump based on the identification of a demand for hot water within the occupancy. The controls shall automatically turn off the pump when the water in the circulation loop is at the desired temperature and when there is no demand for hot water.

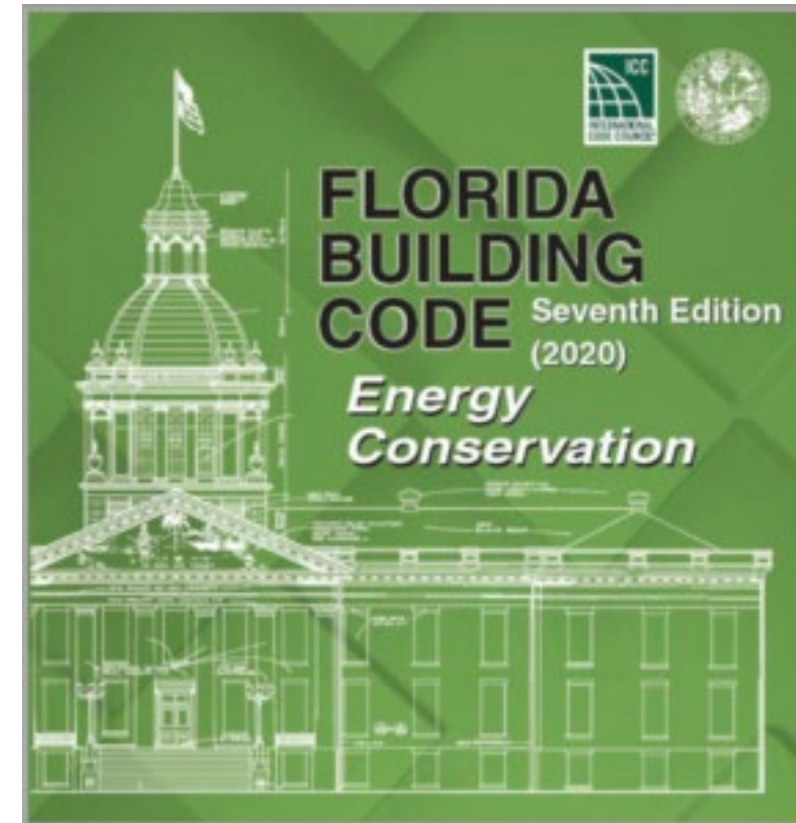

# 2020 Energy Code Commercial

**C404.6.1 Circulation systems.** Heated-water circulation systems shall be provided with a circulation pump. The system return pipe shall be a dedicated return pipe or a cold water supply pipe. Gravity and thermo-syphon circulation systems shall be prohibited. Controls for circulating hot water system pumps shall start the pump based on the identification of a demand for hot water within the occupancy. The controls shall automatically turn off the pump when the water in the circulation loop is at the desired temperature and when there is no demand for hot water.

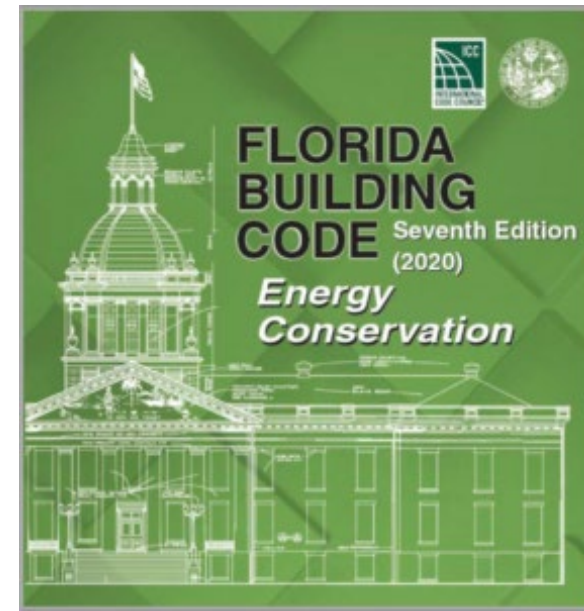

# Design Solutions

## COMMON TYPES OF SYSTEM CONTROLS

**Time Clock**



**Thermostatic Control**



**Flow Control**



# Design Solutions

## **TYPES OF SYSTEM CONTROLS**

**Two Code Requirements are:**

- 1) Start at Demand**
- 2) Stop on Temperature**

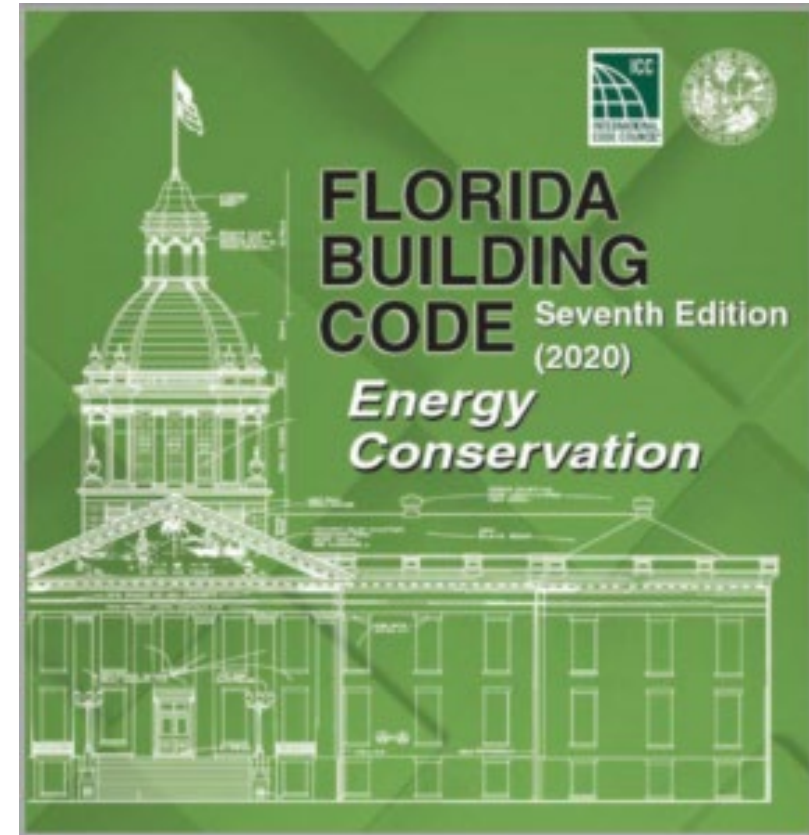

# Design Solutions

## **C404.6 Heated-water circulating and temperature maintenance systems.**

Heated-water circulation systems shall be in accordance with Section C404.6.1. Heat trace temperature maintenance systems shall be in accordance with Section C404.6.2. Controls for hot water storage shall be in accordance with Section C404.6.3. Automatic controls, temperature sensors and pumps shall be accessible. Manual controls shall be readily accessible.

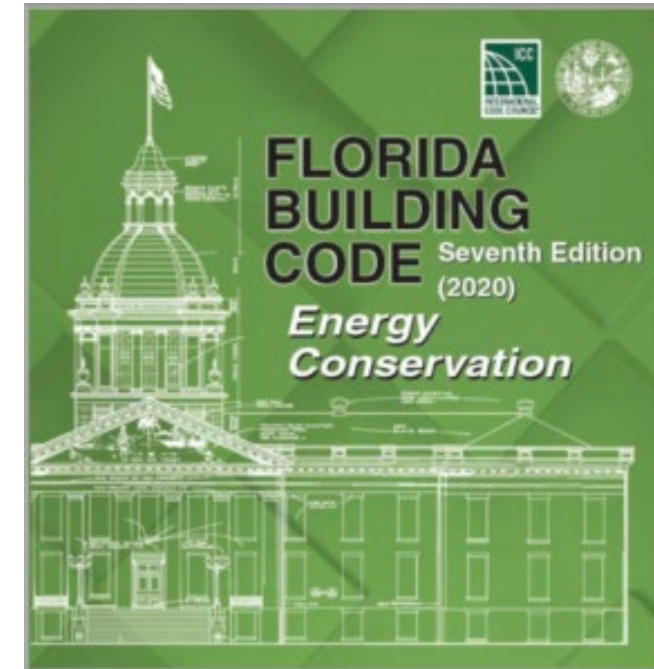



## 2020 Plumbing Code

**607.2.1.2 Demand recirculation controls for distribution systems.** A water distribution system having one or more recirculation pumps that pump water from a heated water supply pipe back to the heated water source through a cold-water supply pipe shall be a demand recirculation water system. Pumps shall have controls that comply with both of the following:

1. The control shall start the pump upon receiving a signal from the action of a user of a fixture or appliance, sensing the presence of a user of a fixture, or sensing the flow of hot or tempered water to a fixture fitting or appliance.
2. The control shall limit the temperature of the water entering the cold-water piping to 104°F (40°C).

**This 2020 Plumbing Code Section Is Identical To 2020 Energy Code Section C404.7 and R403.5.2**

# Design Solutions

**Controls Limit the Time  
The Pump Operates**

**A Time Clock is A  
Simple Demand  
Control**



# Design Solutions

**Controls Limit the Time  
The Pump Operates**

**A Manual  
Switch Can Be  
Used As A  
Demand Control**



# Design Solutions

**Controls Limit the Time  
The Pump Operates**

**A Motion  
Detector Can Be  
Used As A  
Demand Control**



# Design Solutions

**Temperature Controls Limit the Time the Pump Operates by the use of a Sensor in or on the pipe**

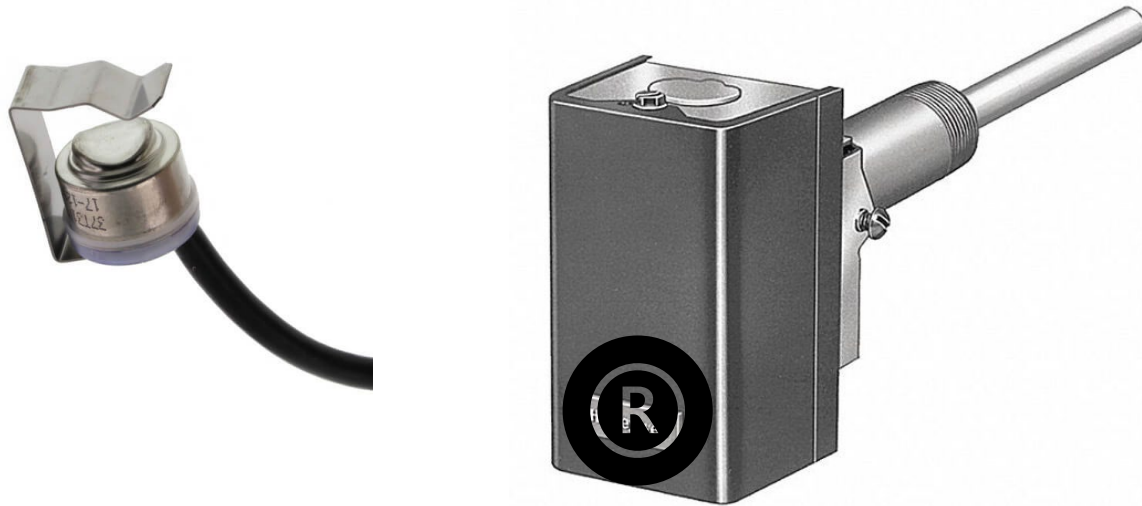

**Temperature Controls**

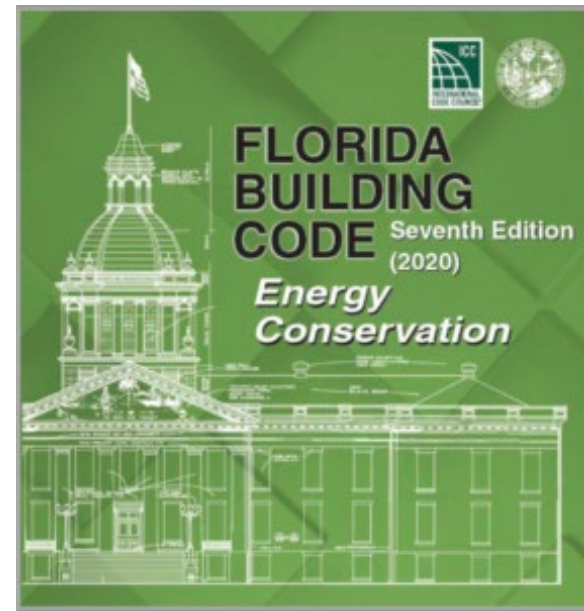

# Design Solutions

**C404.6.1 Circulation systems.** Heated-water circulation systems shall be provided with a circulation pump. The system return pipe shall be a dedicated return pipe or a cold water supply pipe. Gravity and thermo-syphon circulation systems shall be prohibited. Controls for circulating hot water system pumps shall start the pump based on the identification of a demand for hot water within the occupancy.  
The controls shall automatically turn off the pump when the water in the circulation loop is at the desired temperature and when there is no demand for hot water.

# Design Solutions

## QUESTION

**If a Recirculation System has only an Aquastat (Temperature Control) does it comply with the Energy Code?**

**Answer: No**

**A Demand Control is Also Required**

**RECIRCULATION PUMPS SHOULD NOT RUN WHEN A BUSINESS IS CLOSED OR PEOPLE ARE ON VACATION**

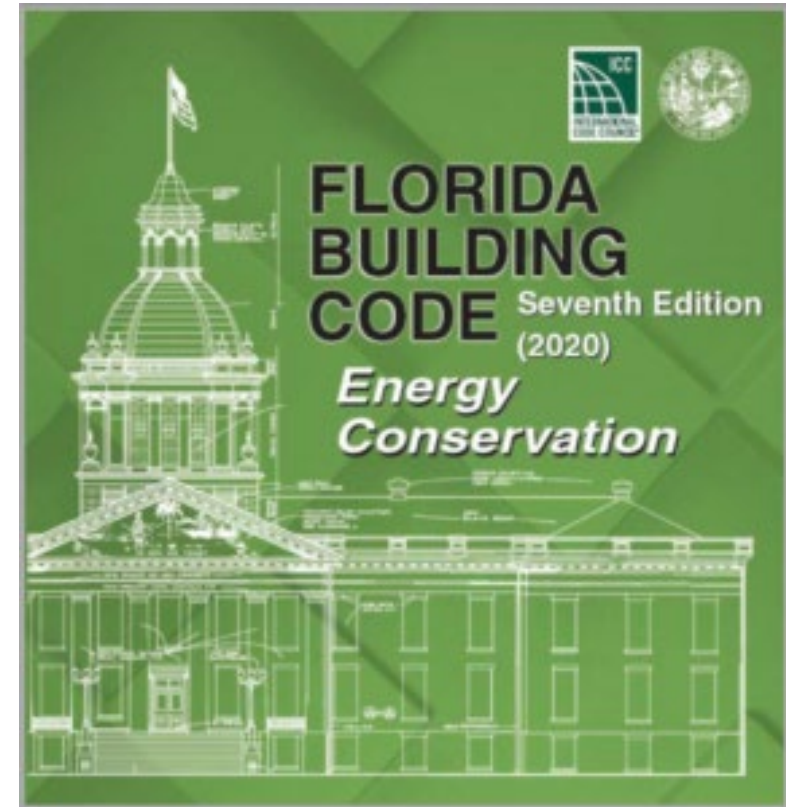

# New Technology

Giovanni Venturi (1746 -1822) Italian Physicist introduced The Venturi Effect which is the change in pressure that results when a fluid flows through a constricted section (or choke) of a pipe.

Original Venturi Tube (1797)

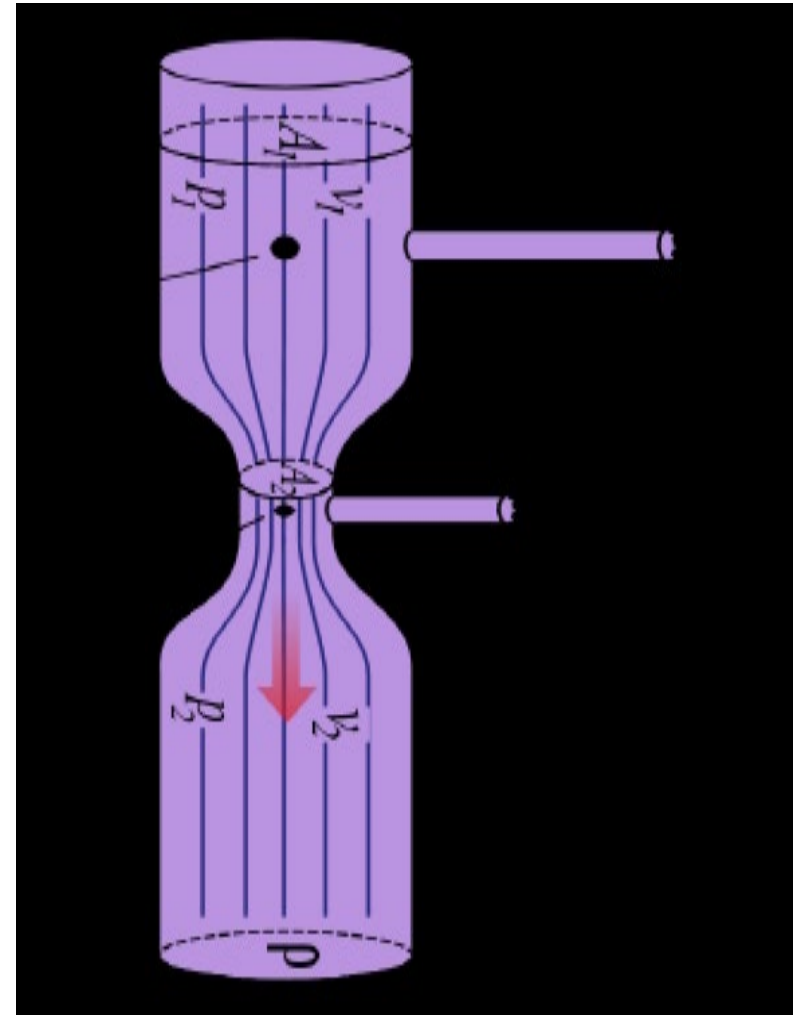



# New Technology

## Code for Public Lavatory Faucets are Very Restrictive

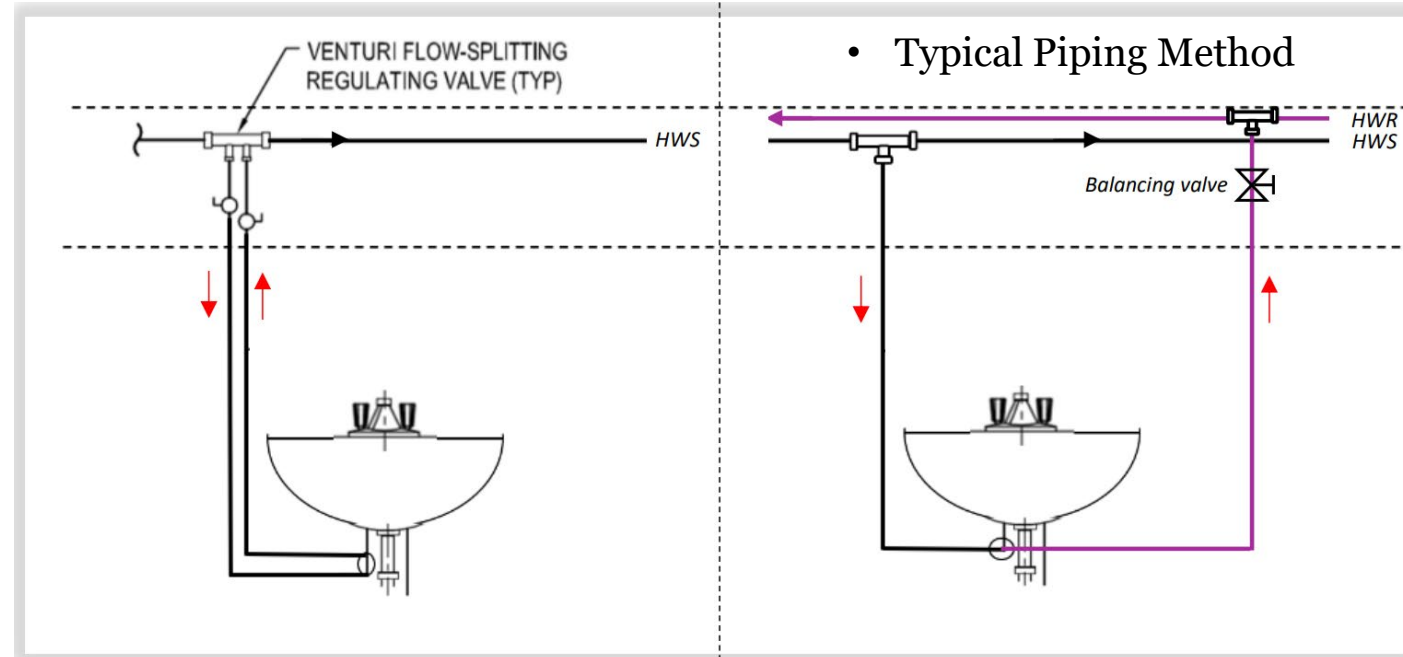

### Cost implications

- *Cost of balancing valve*
- *Cost of ongoing balancing valve adjustments*
- *Cost of additional pipe connections*
- *Cost of return piping*
- *Cost of lost energy due to increased piping*

# New Technology

- **Recirculating Pumps with Wireless Controls**



# New Technology

Wireless Power Controls for Time and Temperature with an APP for your Cell Phone

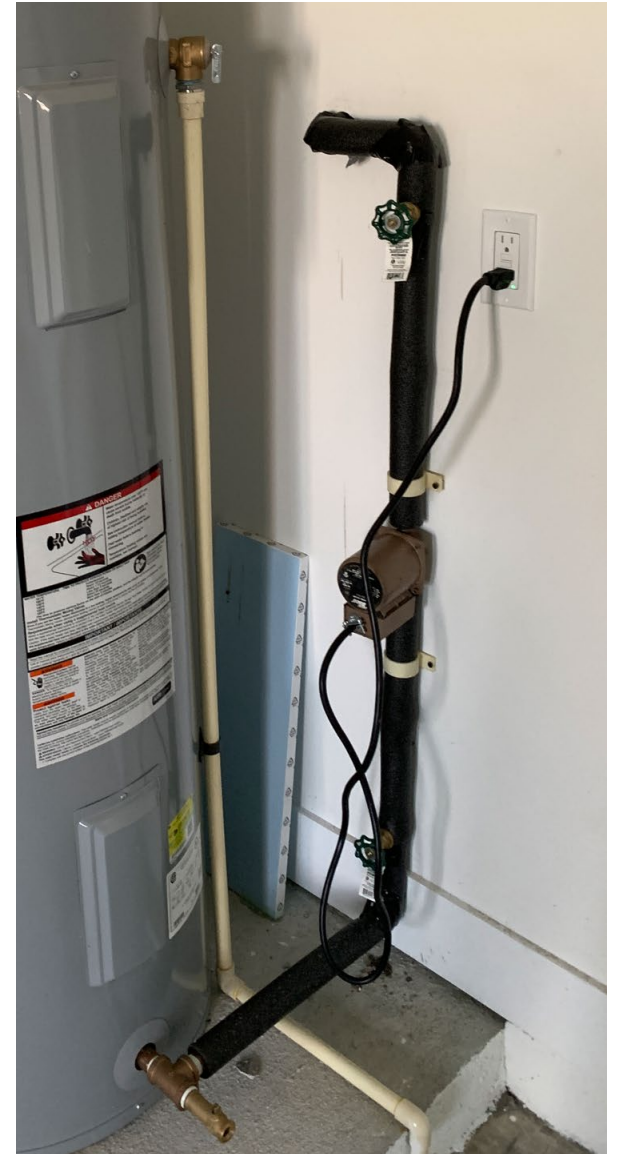

# New Technology

## Smart Controls Kits

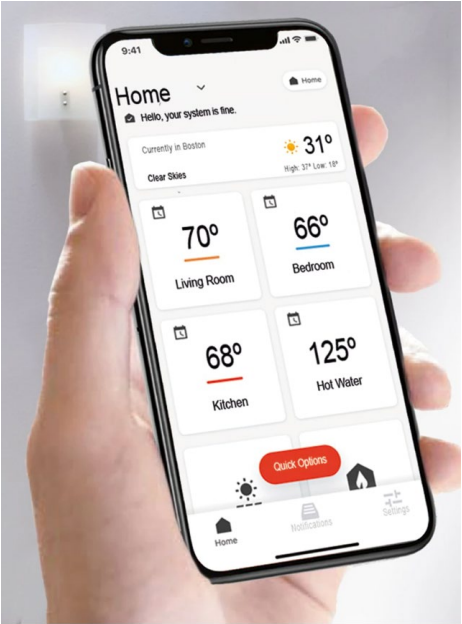

# New Technology

## DEMAND RECIRCULATION WATER SYSTEM Tankless Pump at Heater

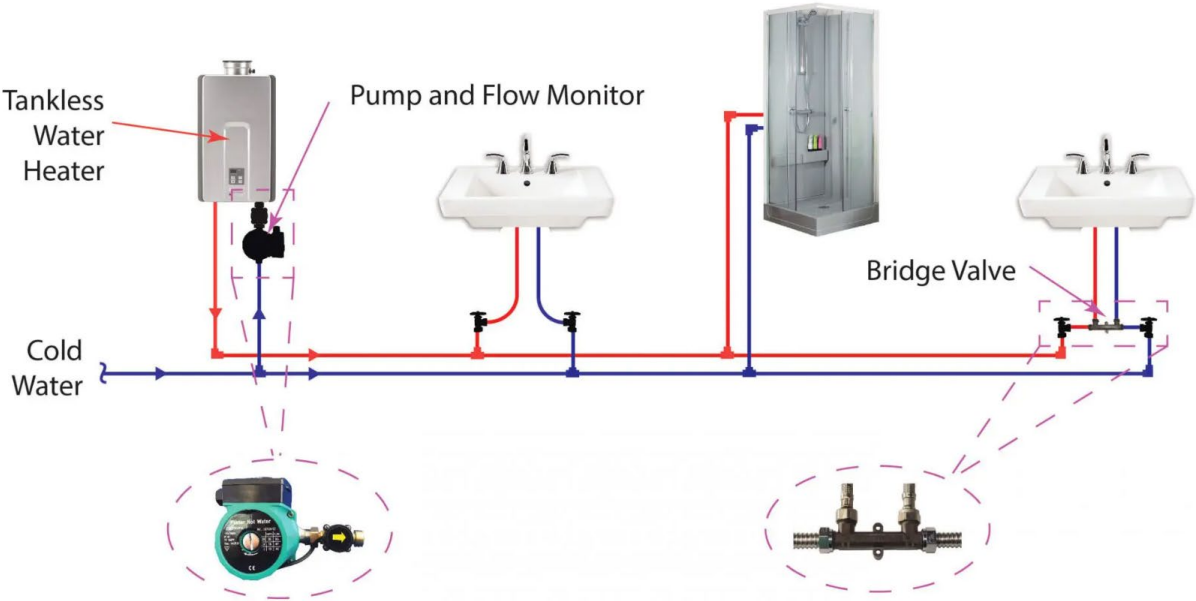

**SAVE UP TO 12,000 GALLONS/YEAR**

# New Technology

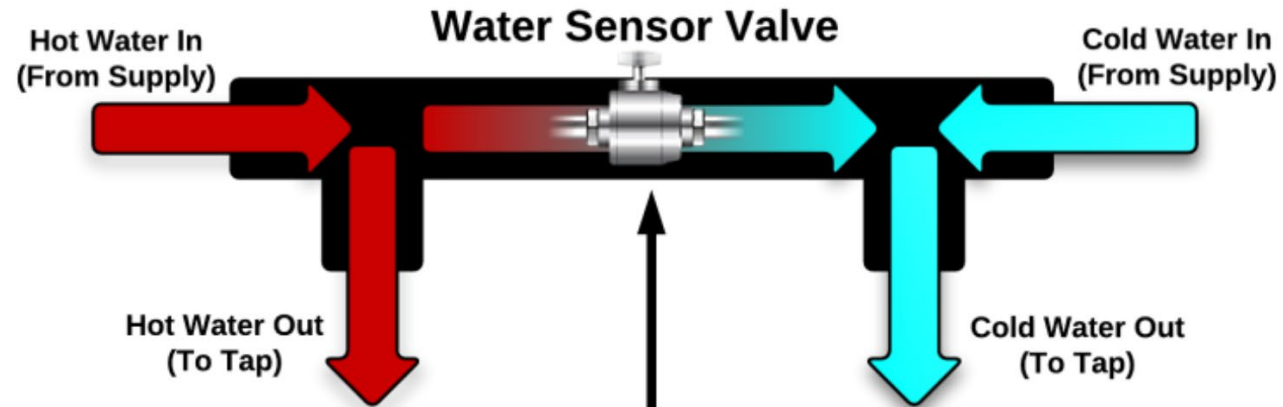

When the water temperature on the hot side is below a certain temperature, the valve opens allowing the water from the hot line to be pumped into the cold side. When the temperature of the hot water reaches the designated temperature, the valve closes, stopping any more water from being pumped.



**Patent on Valve in 2003**

# New Technology



**Some tankless water heaters have built-in pumps with intelligent recirculation software that records your hot water use schedule. Smart recirculation technology tracks each time a significant hot water usage occurs, such as a shower or a bath. The software analyzes your hot water usage pattern and schedules recirculation accordingly. The technology records it and then will schedule recirculation at that same time for the next seven days. It also has an optional module to Wi-Fi enable your tankless water heater and control the schedule from your phone.**

**Any Questions?**

